



CATÁLOGO DE
PERFIS



CIAFLEX
BORRACHAS



FLEXIBILIDADE PARA SOLUCIONAR, CONFIANÇA PARA PERMANECER

CONHEÇA A CIAFLEX



FLEXIBILIDADE PARA SOLUCIONAR, CONFIANÇA PARA PERMANECER

Há 20 anos no mercado, a CIAFLEX tem à sua disposição uma grande variedade de soluções em vedação e acabamento. São perfis esponjosos e maciços, guarnições e prensados, em diversos compostos, durezas e cores, que atendem aos mais variados segmentos.

ACESSE NOSSO SITE E
CONHEÇA **NOSSA LINHA** COMPLETA

PRINCIPAIS DIFERENCIAIS

Desenvolvimento de produtos específicos para atender demandas especiais;

Investimentos em pesquisa e desenvolvimento para buscar alternativas;

Preços competitivos;

Engenharia à disposição do Cliente para desenvolver projetos em conjunto;

Matrizaria para ferramentas de extrusão e de emendas, agilizando os desenvolvimentos;

Elaboração interna dos compostos, garantindo **qualidade;**

Flexibilidade para encontrar soluções e **vencer prazos;**

Laboratório equipado para ensaios, garantindo o atendimento das especificações dos clientes;

NOSSOS PRODUTOS

FLEXIBILIDADE PARA SOLUCIONAR, CONFIANÇA PARA PERMANECER



PERFIS MACIÇOS

Produzimos borrachas em SBR, NBR, EPDM, neoprene e outros na faixa de dureza de 50 a 90 shore A.



PERFIS BIELASTÔMEROS E CANALETAS

Possuímos em nosso mix de produtos bielastômeros e canaletas flocadas para aplicação em diferentes segmentos, dentre eles ônibus, agrícola, indústria e comércio.



PEÇAS TÉCNICAS

Temos em nosso mix de produtos peças técnicas para atender diversas situações, também as desenvolvemos conforme necessidade do cliente.

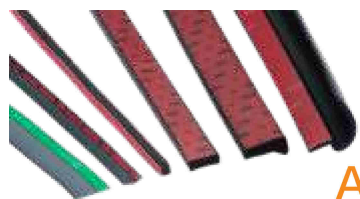

PERFIS ADESIVADOS

Toda a ampla linha de itens produzidos pela Ciaflex pode ser adesivada, seja para finalidades que exijam boa aderência ou somente para posicionamento.



PERFIS COLORIDOS

Padronizamos e personalizamos os produtos com diversas cores e tonalidades. São resistentes a temperatura, intemperismo e possuem excelente acabamento superficial.



PERFIS ESPONJOSOS

Produção de perfis esponjosos para vedação, resistência a temperatura, amortecimento e acabamento para atender aos mais variados segmentos da indústria e comércio, na faixa de dureza de 10 a 40 shore A.

TIPOS DE COLORAÇÃO

PADRÃO RAL
<i>APLICÁVEIS AOS TERMOPLÁSTICOS</i>
Amarelo Limão - 12.362.30
Amarelo RAL 1023 - 15.825.30
Areia - 15.1078.00
Azul Celeste - 17.731.00
Azul Claro RAL 5023 - 17.622.30
Azul Escuro RAL 5005 - 12.004.30
Azul Marinho RAL 5009 - 17.1039.62
Bege RAL 7035 - 11.873.61
Branco RAL 9003 - 18.004.30
Cinza Claro RAL 7039 - 11.673.61
Cinza Escuro RAL 7015
Cinza Especial RAL 7046 - 1046.61
Cinza Médio Escuro RAL 7037
Cinza Médio RAL 7001 - 11.663.61
Laranja RAL 2012 - 14.248.01
Madeira RAL 1001 - 15.835.61
Marrom Claro - 11.002.30
Marrom Escuro RAL 8028 - 13.211.61
Preto RAL 9004 - 11.002.29
Verde Agua RAL 6019 - 12.411.00
Verde RAL 6024 - 015.1185.021
Vermelho RAL 3000 - 1.400.21

TOLERÂNCIAS DIMENSIONAIS

MEDIDAS (mm)	CLASSE E2 ±
0,00 a 1,50	0,25
1,51 a 2,50	0,35
2,51 a 4,00	0,40
4,01 a 6,30	0,50
6,31 a 10,00	0,70
10,01 a 16,00	0,80
16,01 a 25,00	1,00
25,01 a 40,00	1,30
40,01 a 63,00	1,60
63,01 a 100,00	2,00
acima de 100,00	2,0%

DIN ISO 3302-1



ÍNDICE DE CÓDIGOS

CIA 0501	138 /140	CIA 4027	9 /140	CIA 4071	36 /140	CIA 4111	23 /140	CIA 4148	40 /140
CIA 0504	139 /140	CIA 4028	10 /140	CIA 4072	7 /140	CIA 4112	31 /140	CIA 4149	13 /140
CIA 0505	140 /140	CIA 4029	11 /140	CIA 4073	8 /140	CIA 4113	29 /140	CIA 4150	11 /140
CIA 0506	139 /140	CIA 4030	11 /140	CIA 4074	8 /140	CIA 4114	30 /140	CIA 4151	7 /140
CIA 0508	138 /140	CIA 4031	11 /140	CIA 4075	13 /140	CIA 4115	29 /140	CIA 4152	16 /140
CIA 0511	138 /140	CIA 4032	12 /140	CIA 4076	16 /140	CIA 4116	27 /140	CIA 4153	22 /140
CIA 0513	138 /140	CIA 4033	11 /140	CIA 4077	10 /140	CIA 4117	25 /140	CIA 4154	5 /140
CIA 0514	140 /140	CIA 4034	12 /140	CIA 4078	24 /140	CIA 4118	15 /140	CIA 4155	7 /140
CIA 0516	139 /140	CIA 4035	12 /140	CIA 4079	11 /140	CIA 4119	17 /140	CIA 4156	20 /140
CIA 4001	20 /140	CIA 4036	15 /140	CIA 4080	6 /140	CIA 4120	29 /140	CIA 4157	25 /140
CIA 4002	6 /140	CIA 4037	16 /140	CIA 4081	10 /140	CIA 4121	28 /140	CIA 4158	25 /140
CIA 4003	6 /140	CIA 4038	9 /140	CIA 4082	16 /140	CIA 4122	4 /140	CIA 4159	28 /140
CIA 4004	6 /140	CIA 4039	7 /140	CIA 4083	9 /140	CIA 4123	33 /140	CIA 4160	40 /140
CIA 4005	7 /140	CIA 4040	16 /140	CIA 4084	24 /140	CIA 4124	13 /140	CIA 4161	38 /140
CIA 4006	8 /140	CIA 4041	18 /140	CIA 4085	38 /140	CIA 4125	20 /140	CIA 4163	20 /140
CIA 4007	8 /140	CIA 4052	27 /140	CIA 4086	39 /140	CIA 4126	14 /140	CIA 4164	8 /140
CIA 4008	10 /140	CIA 4053	19 /140	CIA 4087	7 /140	CIA 4129	12 /140	CIA 4165	30 /140
CIA 4009	10 /140	CIA 4054	22 /140	CIA 4088	38 /140	CIA 4130	9 /140	CIA 4166	39 /140
CIA 4010	14 /140	CIA 4055	21 /140	CIA 4089	16 /140	CIA 4131	36 /140	CIA 4167	4 /140
CIA 4011	14 /140	CIA 4056	28 /140	CIA 4090	38 /140	CIA 4132	11 /140	CIA 4168	19 /140
CIA 4012	13 /140	CIA 4057	35 /140	CIA 4091	30 /140	CIA 4133	32 /140	CIA 4169	23 /140
CIA 4013	14 /140	CIA 4058	31 /140	CIA 4092	33 /140	CIA 4134	21 /140	CIA 4171	24 /140
CIA 4014	7 /140	CIA 4059	31 /140	CIA 4093	30 /140	CIA 4135	14 /140	CIA 4172	31 /140
CIA 4016	7 /140	CIA 4060	30 /140	CIA 4094	6 /140	CIA 4136	20 /140	CIA 4173	32 /140
CIA 4017	8 /140	CIA 4061	30 /140	CIA 4095	6 /140	CIA 4137	28 /140	CIA 4174	34 /140
CIA 4018	7 /140	CIA 4062	21 /140	CIA 4096	6 /140	CIA 4138	38 /140	CIA 4175	22 /140
CIA 4019	8 /140	CIA 4063	13 /140	CIA 4097	8 /140	CIA 4139	29 /140	CIA 4176	15 /140
CIA 4020	8 /140	CIA 4064	7 /140	CIA 4098	20 /140	CIA 4140	11 /140	CIA 4177	38 /140
CIA 4021	8 /140	CIA 4065	7 /140	CIA 4100	7 /140	CIA 4141	10 /140	CIA 4178	39 /140
CIA 4022	8 /140	CIA 4066	31 /140	CIA 4101	9 /140	CIA 4142	19 /140	CIA 4181	15 /140
CIA 4023	8 /140	CIA 4067	28 /140	CIA 4102	11 /140	CIA 4144	7 /140	CIA 4182	17 /140
CIA 4024	9 /140	CIA 4068	11 /140	CIA 4103	6 /140	CIA 4145	27 /140	CIA 4184	21 /140
CIA 4025	9 /140	CIA 4069	9 /140	CIA 4109	26 /140	CIA 4146	8 /140	CIA 4185	21 /140
CIA 4026	9 /140	CIA 4070	10 /140	CIA 4110	23 /140	CIA 4147	18 /140	CIA 4186	15 /140

CIA 4188	19 /140	CIA 4238	25 /140	CIA 4280	7 /140	CIA 4319	30 /140	CIA 4364	6 /140
CIA 4189	25 /140	CIA 4239	28 /140	CIA 4283	40 /140	CIA 4320	26 /140	CIA 4365	33 /140
CIA 4190	33 /140	CIA 4240	15 /140	CIA 4284	40 /140	CIA 4323	25 /140	CIA 4366	30 /140
CIA 4191	14 /140	CIA 4241	21 /140	CIA 4285	4 /140	CIA 4324	4 /140	CIA 4367	34 /140
CIA 4192	7 /140	CIA 4242	12 /140	CIA 4286	26 /140	CIA 4326	31 /140	CIA 4368	32 /140
CIA 4193	21 /140	CIA 4245	20 /140	CIA 4287	19 /140	CIA 4328	19 /140	CIA 4369	32 /140
CIA 4195	22 /140	CIA 4246	9 /140	CIA 4288	10 /140	CIA 4331	7 /140	CIA 4370	21 /140
CIA 4196	17 /140	CIA 4247	19 /140	CIA 4289	17 /140	CIA 4332	27 /140	CIA 4372	32 /140
CIA 4197	17 /140	CIA 4248	20 /140	CIA 4291	37 /140	CIA 4333	20 /140	CIA 4373	27 /140
CIA 4198	18 /140	CIA 4249	23 /140	CIA 4292	37 /140	CIA 4335	11 /140	CIA 4374	26 /140
CIA 4199	26 /140	CIA 4250	13 /140	CIA 4293	37 /140	CIA 4336	31 /140	CIA 4375	32 /140
CIA 4200	8 /140	CIA 4251	23 /140	CIA 4294	39 /140	CIA 4337	9 /140	CIA 4376	34 /140
CIA 4202	25 /140	CIA 4253	20 /140	CIA 4295	20 /140	CIA 4340	22 /140	CIA 4377	25 /140
CIA 4203	17 /140	CIA 4255	13 /140	CIA 4296	35 /140	CIA 4341	25 /140	CIA 4378	7 /140
CIA 4204	24 /140	CIA 4256	36 /140	CIA 4298	5 /140	CIA 4342	16 /140	CIA 4379	33 /140
CIA 4206	24 /140	CIA 4258	28 /140	CIA 4299	4 /140	CIA 4343	6 /140	CIA 4380	32 /140
CIA 4208	11 /140	CIA 4259	15 /140	CIA 4300	11 /140	CIA 4344	18 /140	CIA 4384	6 /140
CIA 4212	30 /140	CIA 4261	7 /140	CIA 4301	32 /140	CIA 4345	25 /140	CIA 4386	34 /140
CIA 4213	19 /140	CIA 4262	20 /140	CIA 4303	28 /140	CIA 4346	36 /140	CIA 4389	13 /140
CIA 4214	17 /140	CIA 4263	21 /140	CIA 4304	34 /140	CIA 4347	7 /140	CIA 4390	6 /140
CIA 4215	21 /140	CIA 4264	9 /140	CIA 4305	33 /140	CIA 4348	30 /140	CIA 4391	31 /140
CIA 4216	23 /140	CIA 4265	19 /140	CIA 4306	22 /140	CIA 4349	29 /140	CIA 4392	20 /140
CIA 4217	36 /140	CIA 4266	6 /140	CIA 4307	20 /140	CIA 4351	20 /140	CIA 4393	34 /140
CIA 4219	24 /140	CIA 4267	7 /140	CIA 4308	22 /140	CIA 4352	27 /140	CIA 4394	34 /140
CIA 4221	12 /140	CIA 4268	19 /140	CIA 4309	33 /140	CIA 4353	11 /140	CIA 4395	7 /140
CIA 4223	35 /140	CIA 4269	30 /140	CIA 4310	27 /140	CIA 4354	35 /140	CIA 4396	31 /140
CIA 4224	14 /140	CIA 4270	33 /140	CIA 4311	4 /140	CIA 4355	32 /140	CIA 4397	11 /140
CIA 4225	22 /140	CIA 4271	21 /140	CIA 4312	26 /140	CIA 4356	40 /140	CIA 4398	12 /140
CIA 4226	24 /140	CIA 4272	39 /140	CIA 4313	33 /140	CIA 4357	21 /140	CIA 4399	9 /140
CIA 4232	10 /140	CIA 4273	38 /140	CIA 4314	35 /140	CIA 4358	10 /140	CIA 4400	36 /140
CIA 4233	26 /140	CIA 4274	39 /140	CIA 4315	25 /140	CIA 4359	19 /140	CIA 4401	23 /140
CIA 4234	8 /140	CIA 4275	38 /140	CIA 4316	23 /140	CIA 4360	32 /140	CIA 4402	10 /140
CIA 4235	22 /140	CIA 4276	15 /140	CIA 4317	4 /140	CIA 4362	13 /140	CIA 4403	14 /140
CIA 4236	10 /140	CIA 4277	10 /140	CIA 4318	34 /140	CIA 4363	13 /140	CIA 4406	29 /140

CIA 4407	36 /140	CIA 6046	114 /140	CIA 6082	58 /140	CIA 6119	46 /140	CIA 6161	78 /140
CIA 4408	12 /140	CIA 6047	43 /140	CIA 6083	50 /140	CIA 6120	89 /140	CIA 6162	113 /140
CIA 4409	12 /140	CIA 6048	66 /140	CIA 6084	68 /140	CIA 6121	88 /140	CIA 6163	98 /140
CIA 4410	12 /140	CIA 6050	105 /140	CIA 6086	50 /140	CIA 6122	101 /140	CIA 6165	102 /140
CIA 4411	4 /140	CIA 6051	105 /140	CIA 6087	87 /140	CIA 6124	63 /140	CIA 6166	86 /140
CIA 4412	24 /140	CIA 6052	69 /140	CIA 6088	95 /140	CIA 6125	68 /140	CIA 6167	88 /140
CIA 4413	29 /140	CIA 6053	50 /140	CIA 6089	75 /140	CIA 6126	88 /140	CIA 6169	88 /140
CIA 6018	44 /140	CIA 6054	74 /140	CIA 6090	106 /140	CIA 6127	61 /140	CIA 6170	79 /140
CIA 6019	44 /140	CIA 6055	58 /140	CIA 6091	105 /140	CIA 6128	76 /140	CIA 6171	71 /140
CIA 6020	64 /140	CIA 6056	43 /140	CIA 6092	100 /140	CIA 6129	79 /140	CIA 6172	73 /140
CIA 6021	45 /140	CIA 6057	83 /140	CIA 6093	90 /140	CIA 6130	69 /140	CIA 6173	67 /140
CIA 6022	44 /140	CIA 6058	64 /140	CIA 6094	93 /140	CIA 6131	86 /140	CIA 6174	82 /140
CIA 6023	52 /140	CIA 6059	98 /140	CIA 6095	68 /140	CIA 6132	79 /140	CIA 6177	112 /140
CIA 6024	54 /140	CIA 6060	84 /140	CIA 6096	83 /140	CIA 6133	69 /140	CIA 6178	80 /140
CIA 6026	65 /140	CIA 6061	81 /140	CIA 6097	44 /140	CIA 6135	50 /140	CIA 6179	78 /140
CIA 6027	65 /140	CIA 6062	44 /140	CIA 6098	65 /140	CIA 6136	51 /140	CIA 6180	78 /140
CIA 6028	66 /140	CIA 6063	81 /140	CIA 6099	95 /140	CIA 6137	54 /140	CIA 6181	74 /140
CIA 6029	65 /140	CIA 6065	45 /140	CIA 6100	105 /140	CIA 6142	58 /140	CIA 6182	70 /140
CIA 6030	65 /140	CIA 6066	87 /140	CIA 6101	70 /140	CIA 6143	80 /140	CIA 6186	53 /140
CIA 6031	109 /140	CIA 6067	85 /140	CIA 6102	82 /140	CIA 6144	56 /140	CIA 6187	44 /140
CIA 6032	81 /140	CIA 6068	63 /140	CIA 6104	84 /140	CIA 6145	53 /140	CIA 6188	65 /140
CIA 6033	82 /140	CIA 6069	92 /140	CIA 6105	53 /140	CIA 6148	65 /140	CIA 6189	72 /140
CIA 6034	89 /140	CIA 6070	51 /140	CIA 6106	78 /140	CIA 6149	85 /140	CIA 6190	84 /140
CIA 6035	81 /140	CIA 6071	50 /140	CIA 6107	51 /140	CIA 6150	61 /140	CIA 6191	53 /140
CIA 6036	83 /140	CIA 6072	82 /140	CIA 6108	107 /140	CIA 6151	61 /140	CIA 6192	106 /140
CIA 6037	83 /140	CIA 6073	70 /140	CIA 6109	44 /140	CIA 6152	62 /140	CIA 6193	52 /140
CIA 6038	83 /140	CIA 6074	62 /140	CIA 6110	93 /140	CIA 6153	73 /140	CIA 6194	59 /140
CIA 6039	86 /140	CIA 6075	80 /140	CIA 6111	79 /140	CIA 6154	43 /140	CIA 6195	59 /140
CIA 6040	86 /140	CIA 6076	58 /140	CIA 6112	79 /140	CIA 6155	85 /140	CIA 6196	106 /140
CIA 6041	88 /140	CIA 6077	101 /140	CIA 6114	55 /140	CIA 6156	43 /140	CIA 6197	66 /140
CIA 6042	74 /140	CIA 6078	72 /140	CIA 6115	54 /140	CIA 6157	76 /140	CIA 6198	72 /140
CIA 6043	70 /140	CIA 6079	79 /140	CIA 6116	89 /140	CIA 6158	72 /140	CIA 6199	53 /140
CIA 6044	70 /140	CIA 6080	82 /140	CIA 6117	69 /140	CIA 6159	52 /140	CIA 6200	54 /140
CIA 6045	81 /140	CIA 6081	67 /140	CIA 6118	89 /140	CIA 6160	84 /140	CIA 6201	44 /140

ÍNDICE DE CÓDIGOS

CIA 6202	45 /140	CIA 6241	66 /140	CIA 6276	53 /140	CIA 6315	75 /140	CIA 6354	90 /140
CIA 6203	110 /140	CIA 6242	71 /140	CIA 6277	55 /140	CIA 6316	68 /140	CIA 6355	75 /140
CIA 6204	59 /140	CIA 6243	77 /140	CIA 6278	57 /140	CIA 6318	83 /140	CIA 6356	44 /140
CIA 6205	53 /140	CIA 6244	83 /140	CIA 6279	57 /140	CIA 6319	72 /140	CIA 6357	90 /140
CIA 6206	64 /140	CIA 6245	83 /140	CIA 6281	55 /140	CIA 6321	44 /140	CIA 6358	44 /140
CIA 6207	75 /140	CIA 6246	73 /140	CIA 6282	56 /140	CIA 6322	70 /140	CIA 6359	93 /140
CIA 6208	100 /140	CIA 6247	97 /140	CIA 6283	56 /140	CIA 6323	88 /140	CIA 6360	104 /140
CIA 6209	56 /140	CIA 6248	56 /140	CIA 6284	101 /140	CIA 6324	50 /140	CIA 6361	51 /140
CIA 6210	108 /140	CIA 6249	56 /140	CIA 6285	102 /140	CIA 6325	51 /140	CIA 6362	99 /140
CIA 6213	103 /140	CIA 6250	57 /140	CIA 6286	82 /140	CIA 6326	62 /140	CIA 6363	103 /140
CIA 6214	92 /140	CIA 6251	55 /140	CIA 6287	105 /140	CIA 6327	82 /140	CIA 6364	60 /140
CIA 6215	92 /140	CIA 6252	55 /140	CIA 6288	79 /140	CIA 6328	97 /140	CIA 6365	61 /140
CIA 6216	70 /140	CIA 6253	55 /140	CIA 6289	72 /140	CIA 6329	84 /140	CIA 6366	61 /140
CIA 6217	76 /140	CIA 6254	84 /140	CIA 6290	57 /140	CIA 6330	65 /140	CIA 6367	91 /140
CIA 6218	53 /140	CIA 6255	85 /140	CIA 6291	81 /140	CIA 6332	84 /140	CIA 6368	81 /140
CIA 6219	98 /140	CIA 6256	105 /140	CIA 6293	70 /140	CIA 6333	78 /140	CIA 6369	109 /140
CIA 6220	81 /140	CIA 6257	54 /140	CIA 6294	85 /140	CIA 6334	65 /140	CIA 6370	78 /140
CIA 6221	106 /140	CIA 6258	83 /140	CIA 6295	65 /140	CIA 6335	80 /140	CIA 6371	60 /140
CIA 6222	91 /140	CIA 6259	51 /140	CIA 6297	51 /140	CIA 6337	76 /140	CIA 6372	88 /140
CIA 6223	82 /140	CIA 6260	51 /140	CIA 6298	54 /140	CIA 6338	66 /140	CIA 6373	76 /140
CIA 6224	83 /140	CIA 6261	55 /140	CIA 6299	55 /140	CIA 6339	108 /140	CIA 6375	137 /140
CIA 6225	73 /140	CIA 6262	53 /140	CIA 6300	82 /140	CIA 6340	108 /140	CIA 6378	78 /140
CIA 6226	90 /140	CIA 6263	53 /140	CIA 6301	68 /140	CIA 6341	111 /140	CIA 6379	52 /140
CIA 6227	79 /140	CIA 6264	55 /140	CIA 6302	62 /140	CIA 6342	93 /140	CIA 6380	97 /140
CIA 6228	63 /140	CIA 6265	66 /140	CIA 6303	73 /140	CIA 6343	59 /140	CIA 6381	87 /140
CIA 6229	52 /140	CIA 6266	79 /140	CIA 6305	72 /140	CIA 6344	54 /140	CIA 6382	82 /140
CIA 6230	92 /140	CIA 6267	86 /140	CIA 6306	60 /140	CIA 6345	105 /140	CIA 6383	69 /140
CIA 6231	53 /140	CIA 6268	85 /140	CIA 6307	87 /140	CIA 6346	98 /140	CIA 6385	75 /140
CIA 6233	97 /140	CIA 6269	44 /140	CIA 6308	65 /140	CIA 6348	80 /140	CIA 6386	91 /140
CIA 6234	64 /140	CIA 6270	57 /140	CIA 6309	68 /140	CIA 6349	79 /140	CIA 6387	91 /140
CIA 6235	79 /140	CIA 6271	55 /140	CIA 6310	53 /140	CIA 6350	43 /140	CIA 6388	45 /140
CIA 6237	60 /140	CIA 6273	86 /140	CIA 6311	50 /140	CIA 6351	137 /140	CIA 6390	89 /140
CIA 6238	66 /140	CIA 6274	51 /140	CIA 6312	98 /140	CIA 6352	59 /140	CIA 6391	80 /140
CIA 6239	109 /140	CIA 6275	53 /140	CIA 6313	74 /140	CIA 6353	79 /140	CIA 6392	88 /140

CIA 6393	87 /140	CIA 6434	79 /140	CIA 6352	59 /140	CIA 7006	86 /140	CIA 7064	53 /140
CIA 6394	69 /140	CIA 6435	95 /140	CIA 6470	75 /140	CIA 7008	82 /140	CIA 7065	66 /140
CIA 6395	52 /140	CIA 6436	90 /140	CIA 6471	50 /140	CIA 7009	80 /140	CIA 7066	68 /140
CIA 6396	89 /140	CIA 6437	104 /140	CIA 6472	65 /140	CIA 7010	84 /140	CIA 7069	67 /140
CIA 6397	107 /140	CIA 6438	104 /140	CIA 6473	51 /140	CIA 7014	79 /140	CIA 7070	76 /140
CIA 6399	77 /140	CIA 6439	74 /140	CIA 6474	51 /140	CIA 7016	63 /140	CIA 7072	93 /140
CIA 6400	78 /140	CIA 6440	68 /140	CIA 6475	115 /140	CIA 7018	64 /140	CIA 7073	96 /140
CIA 6401	58 /140	CIA 6441	85 /140	CIA 6476	88 /140	CIA 7019	66 /140	CIA 7074	63 /140
CIA 6402	58 /140	CIA 6442	54 /140	CIA 6477	52 /140	CIA 7020	72 /140	CIA 7075	66 /140
CIA 6403	89 /140	CIA 6443	84 /140	CIA 6478	93 /140	CIA 7021	96 /140	CIA 7076	88 /140
CIA 6406	71 /140	CIA 6444	83 /140	CIA 6479	50 /140	CIA 7022	96 /140	CIA 7077	57 /140
CIA 6407	96 /140	CIA 6445	88 /140	CIA 6480	66 /140	CIA 7023	66 /140	CIA 7078	81 /140
CIA 6408	93 /140	CIA 6446	102 /140	CIA 6481	95 /140	CIA 7025	92 /140	CIA 7079	83 /140
CIA 6409	54 /140	CIA 6447	77 /140	CIA 6482	75 /140	CIA 7026	60 /140	CIA 7080	81 /140
CIA 6410	69 /140	CIA 6448	88 /140	CIA 6483	106 /140	CIA 7028	72 /140	CIA 7081	90 /140
CIA 6411	100 /140	CIA 6449	51 /140	CIA 6485	75 /140	CIA 7029	108 /140	CIA 7082	90 /140
CIA 6412	69 /140	CIA 6450	53 /140	CIA 6486	51 /140	CIA 7030	81 /140	CIA 7083	68 /140
CIA 6413	58 /140	CIA 6451	101 /140	CIA 6487	103 /140	CIA 7031	67 /140	CIA 9001	117 /140
CIA 6414	91 /140	CIA 6452	86 /140	CIA 6488	108 /140	CIA 7033	72 /140	CIA 9002	118 /140
CIA 6415	91 /140	CIA 6453	54 /140	CIA 6490	80 /140	CIA 7038	78 /140	CIA 9003	134 /140
CIA 6416	73 /140	CIA 6454	64 /140	CIA 6491	103 /140	CIA 7041	66 /140	CIA 9004	116 /140
CIA 6418	87 /140	CIA 6455	89 /140	CIA 6492	77 /140	CIA 7048	66 /140	CIA 9005	124 /140
CIA 6419	86 /140	CIA 6456	77 /140	CIA 6493	106 /140	CIA 7049	88 /140	CIA 9006	121 /140
CIA 6420	84 /140	CIA 6457	69 /140	CIA 6495	50 /140	CIA 7050	60 /140	CIA 9007	118 /140
CIA 6421	99 /140	CIA 6458	50 /140	CIA 6498	95 /140	CIA 7051	59 /140	CIA 9008	122 /140
CIA 6422	104 /140	CIA 6460	83 /140	CIA 6500	98 /140	CIA 7052	59 /140	CIA 9009	121 /140
CIA 6423	74 /140	CIA 6461	43 /140	CIA 6501	137 /140	CIA 7054	66 /140	CIA 9010	121 /140
CIA 6424	78 /140	CIA 6462	81 /140	CIA 6502	137 /140	CIA 7055	45 /140	CIA 9011	121 /140
CIA 6425	50 /140	CIA 6463	93 /140	CIA 6504	65 /140	CIA 7056	88 /140	CIA 9012	115 /140
CIA 6427	93 /140	CIA 6464	52 /140	CIA 6506	117 /140	CIA 7057	66 /140	CIA 9013	122 /140
CIA 6428	68 /140	CIA 6465	76 /140	CIA 6507	93 /140	CIA 7058	65 /140	CIA 9014	116 /140
CIA 6430	64 /140	CIA 6466	52 /140	CIA 6509	80 /140	CIA 7059	72 /140	CIA 9015	116 /140
CIA 6432	74 /140	CIA 6469	79 /140	CIA 7002	66 /140	CIA 7060	92 /140	CIA 9016	117 /140
CIA 6433	43 /140	CIA 6351	137 /140	CIA 7004	80 /140	CIA 7061	92 /140	CIA 9017	119 /140

CIA 9018	116 /140	CIA 9053	121 /140	CIA 9090	115 /140	CIA 9129	131 /140	CIA 14114	80 /140
CIA 9019	122 /140	CIA 9054	117 /140	CIA 9091	118 /140	CIA 9130	132 /140	CIA 14117	77 /140
CIA 9020	133 /140	CIA 9055	115 /140	CIA 9092	131 /140	CIA 9131	132 /140	CIA 14120	89 /140
CIA 9021	120 /140	CIA 9056	115 /140	CIA 9093	119 /140	CIA 9132	100 /140	CIA 14121	30 /140
CIA 9022	121 /140	CIA 9057	119 /140	CIA 9094	122 /140	CIA 9133	115 /140	CIA 14170	82 /140
CIA 9023	119 /140	CIA 9058	89 /140	CIA 9095	127 /140	CIA 9134	108 /140	CIA 14199	119 /140
CIA 9024	127 /140	CIA 9059	115 /140	CIA 9096	129 /140	CIA 9138	117 /140	CIA 14205	54 /140
CIA 9025	122 /140	CIA 9060	121 /140	CIA 9097	132 /140	CIA 9139	125 /140	CIA 14229	33 /140
CIA 9026	120 /140	CIA 9061	126 /140	CIA 9098	121 /140	CIA 9140	130 /140	CIA 14245	139 /140
CIA 9027	126 /140	CIA 9062	122 /140	CIA 9100	127 /140	CIA 9141	119 /140	CIA 14250	67 /140
CIA 9028	120 /140	CIA 9063	120 /140	CIA 9102	128 /140	CIA 9142	125 /140	CIA 14251	19 /140
CIA 9029	117 /140	CIA 9064	133 /140	CIA 9103	117 /140	CIA 9143	127 /140	CIA 14252	104 /140
CIA 9031	116 /140	CIA 9065	116 /140	CIA 9106	126 /140	CIA 9144	110 /140	CIA 14260	63 /140
CIA 9032	117 /140	CIA 9066	122 /140	CIA 9107	119 /140	CIA 9145	132 /140	CIA 14261	123 /140
CIA 9033	115 /140	CIA 9068	119 /140	CIA 9108	116 /140	CIA 9146	116 /140	CIA 14263	121 /140
CIA 9034	115 /140	CIA 9070	117 /140	CIA 9109	119 /140	CIA 9147	130 /140	CIA 14299	123 /140
CIA 9035	116 /140	CIA 9072	133 /140	CIA 9111	125 /140	CIA 9148	130 /140	CIA 14317	68 /140
CIA 9036	116 /140	CIA 9073	127 /140	CIA 9112	117 /140	CIA 9151	115 /140	CIA 14320	23 /140
CIA 9037	115 /140	CIA 9074	121 /140	CIA 9113	124 /140	CIA 9152	134 /140	CIA 14341	6 /140
CIA 9038	115 /140	CIA 9075	126 /140	CIA 9114	135 /140	CIA 9153	134 /140	CIA 14360	52 /140
CIA 9039	118 /140	CIA 9076	120 /140	CIA 9115	128 /140	CIA 9154	110 /140	CIA 14365	69 /140
CIA 9040	134 /140	CIA 9077	127 /140	CIA 9116	107 /140	CIA 9155	57 /140	CIA 14379	74 /140
CIA 9041	123 /140	CIA 9078	124 /140	CIA 9117	96 /140	CIA 9156	104 /140	CIA 14380	74 /140
CIA 9042	129 /140	CIA 9079	123 /140	CIA 9118	107 /140	CIA 9157	118 /140	CIA 14381	77 /140
CIA 9043	123 /140	CIA 9080	120 /140	CIA 9119	120 /140	CIA 9158	129 /140	CIA 14383	49 /140
CIA 9044	122 /140	CIA 9081	119 /140	CIA 9120	128 /140	CIA 9159	128 /140	CIA 14401	126 /140
CIA 9045	122 /140	CIA 9082	122 /140	CIA 9121	130 /140	CIA 9160	125 /140	CIA 14402	126 /140
CIA 9046	122 /140	CIA 9083	130 /140	CIA 9122	116 /140	CIA 9161	135 /140	CIA 14403	125 /140
CIA 9047	116 /140	CIA 9084	115 /140	CIA 9123	131 /140	CIA 9162	49 /140	CIA 14413	77 /140
CIA 9048	116 /140	CIA 9085	116 /140	CIA 9124	97 /140	CIA 14029	89 /140	CIA 14450	80 /140
CIA 9049	120 /140	CIA 9086	120 /140	CIA 9125	116 /140	CIA 14037	50 /140	CIA 14453	69 /140
CIA 9050	126 /140	CIA 9087	117 /140	CIA 9126	129 /140	CIA 14065	106 /140	CIA 14454	69 /140
CIA 9051	135 /140	CIA 9088	134 /140	CIA 9127	128 /140	CIA 14088	81 /140	CIA 14518	82 /140
CIA 9052	118 /140	CIA 9089	118 /140	CIA 9128	126 /140	CIA 14089	58 /140	CIA 14526	80 /140

ÍNDICE DE CÓDIGOS

CIA 14534	33 /140	CIA 15063	6 /140	CIA 15895	29 /140	CIA 16436	76 /140	CIA 16633	109 /140
CIA 14537	33 /140	CIA 15073	110 /140	CIA 15937	25 /140	CIA 16440	28 /140	CIA 16641	28 /140
CIA 14554	46 /140	CIA 15075	99 /140	CIA 15973	123 /140	CIA 16453	85 /140	CIA 16642	30 /140
CIA 14555	45 /140	CIA 15082	124 /140	CIA 15974	118 /140	CIA 16462	43 /140	CIA 16643	112 /140
CIA 14556	6 /140	CIA 15127	103 /140	CIA 15980	61 /140	CIA 16463	44 /140	CIA 16653	14 /140
CIA 14578	81 /140	CIA 15169	14 /140	CIA 16000	63 /140	CIA 16473	58 /140	CIA 16656	8 /140
CIA 14579	60 /140	CIA 15234	81 /140	CIA 16010	51 /140	CIA 16474	59 /140	CIA 16658	22 /140
CIA 14619	57 /140	CIA 15235	83 /140	CIA 16011	51 /140	CIA 16483	86 /140	CIA 16659	85 /140
CIA 14625	90 /140	CIA 15236	83 /140	CIA 16012	53 /140	CIA 16496	99 /140	CIA 16665	26 /140
CIA 14664	123 /140	CIA 15237	83 /140	CIA 16022	136 /140	CIA 16509	94 /140	CIA 16666	82 /140
CIA 14697	135 /140	CIA 15251	77 /140	CIA 16031	102 /140	CIA 16510	94 /140	CIA 16668	45 /140
CIA 14803	118 /140	CIA 15379	29 /140	CIA 16032	43 /140	CIA 16515	117 /140	CIA 16671	139 /140
CIA 14804	125 /140	CIA 15404	97 /140	CIA 16081	22 /140	CIA 16529	45 /140	CIA 16674	27 /140
CIA 14832	67 /140	CIA 15423	133 /140	CIA 16083	93 /140	CIA 16533	138 /140	CIA 16679	62 /140
CIA 14833	66 /140	CIA 15456	27 /140	CIA 16118	52 /140	CIA 16535	78 /140	CIA 16688	22 /140
CIA 14835	82 /140	CIA 15457	32 /140	CIA 16152	137 /140	CIA 16536	77 /140	CIA 16692	139 /140
CIA 14836	79 /140	CIA 15467	128 /140	CIA 16157	137 /140	CIA 16552	28 /140	CIA 16705	4 /140
CIA 14837	88 /140	CIA 15623	62 /140	CIA 16176	84 /140	CIA 16559	41 /140	CIA 16707	61 /140
CIA 14838	74 /140	CIA 15634	84 /140	CIA 16198	45 /140	CIA 16564	59 /140	CIA 16708	61 /140
CIA 14840	64 /140	CIA 15703	91 /140	CIA 16211	53 /140	CIA 16568	8 /140	CIA 16721	67 /140
CIA 14841	115 /140	CIA 15710	31 /140	CIA 16212	67 /140	CIA 16569	15 /140	CIA 16741	24 /140
CIA 14842	111 /140	CIA 15711	67 /140	CIA 16238	67 /140	CIA 16570	138 /140	CIA 16742	111 /140
CIA 14847	119 /140	CIA 15750	91 /140	CIA 16249	45 /140	CIA 16574	76 /140	CIA 16746	67 /140
CIA 14851	22 /140	CIA 15780	67 /140	CIA 16266	64 /140	CIA 16587	63 /140	CIA 16749	6 /140
CIA 14882	136 /140	CIA 15781	89 /140	CIA 16298	86 /140	CIA 16590	43 /140	CIA 16750	50 /140
CIA 14937	90 /140	CIA 15814	9 /140	CIA 16300	64 /140	CIA 16591	18 /140	CIA 16751	50 /140
CIA 14943	99 /140	CIA 15818	88 /140	CIA 16311	90 /140	CIA 16592	29 /140	CIA 16754	90 /140
CIA 14954	64 /140	CIA 15819	78 /140	CIA 16313	87 /140	CIA 16599	11 /140	CIA 16757	137 /140
CIA 15006	36 /140	CIA 15825	100 /140	CIA 16315	87 /140	CIA 16601	30 /140	CIA 16768	13 /140
CIA 15020	37 /140	CIA 15826	100 /140	CIA 16316	87 /140	CIA 16602	10 /140	CIA 16770	50 /140
CIA 15024	35 /140	CIA 15827	94 /140	CIA 16326	63 /140	CIA 16604	32 /140	CIA 16774	6 /140
CIA 15031	124 /140	CIA 15875	115 /140	CIA 16329	47 /140	CIA 16618	67 /140	CIA 16778	92 /140
CIA 15048	81 /140	CIA 15883	64 /140	CIA 16379	26 /140	CIA 16622	121 /140	CIA 16779	92 /140
CIA 15057	119 /140	CIA 15887	63 /140	CIA 16428	44 /140	CIA 16628	45 /140	CIA 16780	22 /140

CIA 16787	21 /140	CIA 17095	43 /140	CIA 17433	52 /140	CIA 17696	10 /140	CIA 17959	27 /140
CIA 16789	6 /140	CIA 17116	120 /140	CIA 17437	26 /140	CIA 17697	14 /140	CIA 17969	74 /140
CIA 16801	60 /140	CIA 17124	94 /140	CIA 17450	46 /140	CIA 17703	43 /140	CIA 17974	74 /140
CIA 16803	114 /140	CIA 17125	94 /140	CIA 17455	47 /140	CIA 17704	71 /140	CIA 17994	72 /140
CIA 16805	88 /140	CIA 17134	26 /140	CIA 17482	82 /140	CIA 17741	29 /140	CIA 17995	76 /140
CIA 16810	94 /140	CIA 17145	87 /140	CIA 17485	73 /140	CIA 17760	62 /140	CIA 18017	110 /140
CIA 16817	62 /140	CIA 17166	139 /140	CIA 17488	71 /140	CIA 17766	46 /140	CIA 18044	74 /140
CIA 16818	85 /140	CIA 17171	58 /140	CIA 17489	111 /140	CIA 17790	54 /140	CIA 18056	77 /140
CIA 16823	95 /140	CIA 17172	61 /140	CIA 17491	94 /140	CIA 17806	45 /140	CIA 18057	76 /140
CIA 16833	8 /140	CIA 17173	80 /140	CIA 17515	47 /140	CIA 17838	67 /140	CIA 18059	70 /140
CIA 16843	116 /140	CIA 17198	104 /140	CIA 17516	60 /140	CIA 17842	56 /140	CIA 18060	6 /140
CIA 16844	9 /140	CIA 17202	16 /140	CIA 17517	60 /140	CIA 17846	93 /140	CIA 18061	13 /140
CIA 16845	124 /140	CIA 17217	92 /140	CIA 17518	60 /140	CIA 17848	14 /140	CIA 18080	77 /140
CIA 16857	113 /140	CIA 17222	67 /140	CIA 17521	112 /140	CIA 17849	44 /140	CIA 18081	92 /140
CIA 16859	10 /140	CIA 17237	58 /140	CIA 17523	124 /140	CIA 17850	57 /140	CIA 18084	27 /140
CIA 16866	25 /140	CIA 17246	28 /140	CIA 17527	107 /140	CIA 17852	29 /140	CIA 18088	75 /140
CIA 16867	67 /140	CIA 17263	136 /140	CIA 17542	123 /140	CIA 17853	29 /140	CIA 18089	75 /140
CIA 16868	35 /140	CIA 17311	107 /140	CIA 17543	121 /140	CIA 17854	93 /140	CIA 18105	70 /140
CIA 16892	92 /140	CIA 17314	90 /140	CIA 17546	81 /140	CIA 17861	27 /140	CIA 18109	51 /140
CIA 16897	69 /140	CIA 17325	56 /140	CIA 17548	27 /140	CIA 17864	43 /140	CIA 18126	71 /140
CIA 16901	75 /140	CIA 17327	69 /140	CIA 17554	2 /140	CIA 17865	44 /140	CIA 18127	76 /140
CIA 16952	137 /140	CIA 17332	63 /140	CIA 17560	50 /140	CIA 17866	44 /140	CIA 18128	4 /140
CIA 16958	34 /140	CIA 17338	140 /140	CIA 17561	48 /140	CIA 17867	12 /140	CIA 18130	46 /140
CIA 16961	15 /140	CIA 17340	56 /140	CIA 17570	15 /140	CIA 17873	11 /140	CIA 18132	46 /140
CIA 16964	22 /140	CIA 17362	91 /140	CIA 17590	92 /140	CIA 17874	13 /140	CIA 18143	105 /140
CIA 16998	23 /140	CIA 17372	10 /140	CIA 17591	92 /140	CIA 17895	25 /140	CIA 18144	49 /140
CIA 16992	18 /140	CIA 17376	12 /140	CIA 17592	92 /140	CIA 17903	99 /140	CIA 18154	71 /140
CIA 17011	91 /140	CIA 17387	62 /140	CIA 17608	46 /140	CIA 17906	124 /140	CIA 18155	70 /140
CIA 17012	74 /140	CIA 17388	137 /140	CIA 17631	55 /140	CIA 17913	94 /140	CIA 18156	70 /140
CIA 17058	11 /140	CIA 17389	54 /140	CIA 17644	50 /140	CIA 17924	61 /140	CIA 18157	70 /140
CIA 17063	6 /140	CIA 17400	96 /140	CIA 17664	5 /140	CIA 17935	61 /140	CIA 18158	70 /140
CIA 17067	4 /140	CIA 17406	31 /140	CIA 17667	54 /140	CIA 17942	26 /140	CIA 18174	81 /140
CIA 17072	75 /140	CIA 17419	94 /140	CIA 17686	138 /140	CIA 17943	28 /140	CIA 18175	28 /140
CIA 17090	31 /140	CIA 17431	11 /140	CIA 17694	29 /140	CIA 17946	64 /140	CIA 18182	52 /140

ÍNDICE DE CÓDIGOS



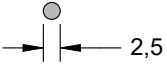
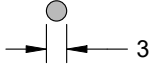
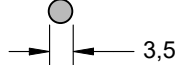
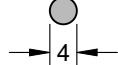
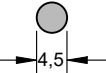
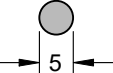
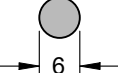
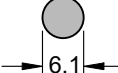
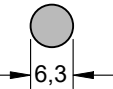
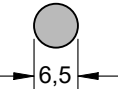
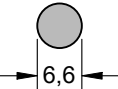
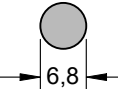
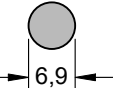
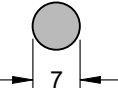
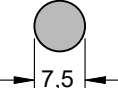
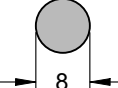

CIA 18186	69 /140	CIA 18274	41 /140	CIA 18332	73 /140	CIA 18377	2 /140	CIA 18416	63 /140
CIA 18189	54 /140	CIA 18275	41 /140	CIA 18333	73 /140	CIA 18378	2 /140	CIA 18417	13 /140
CIA 18190	122 /140	CIA 18276	42 /140	CIA 18335	1 /140	CIA 18379	2 /140	CIA 18425	47 /140
CIA 18199	126 /140	CIA 18277	42 /140	CIA 18336	2 /140	CIA 18380	2 /140	CIA 18446	37 /140
CIA 18217	139 /140	CIA 18278	42 /140	CIA 18343	25 /140	CIA 18381	2 /140	CIA 18452	91 /140
CIA 18227	42 /140	CIA 18279	42 /140	CIA 18345	1 /140	CIA 18382	2 /140	CIA 18455	72 /140
CIA 18228	42 /140	CIA 18280	42 /140	CIA 18346	1 /140	CIA 18383	2 /140	CIA 18457	111 /140
CIA 18230	71 /140	CIA 18281	42 /140	CIA 18347	1 /140	CIA 18384	2 /140	CIA 18479	113 /140
CIA 18231	72 /140	CIA 18282	42 /140	CIA 18348	1 /140	CIA 18386	2 /140	CIA 18480	14 /140
CIA 18232	70 /140	CIA 18283	42 /140	CIA 18351	1 /140	CIA 18387	2 /140	CIA 18502	3 /140
CIA 18233	71 /140	CIA 18284	42 /140	CIA 18352	1 /140	CIA 18388	2 /140	CIA 18514	8 /140
CIA 18234	70 /140	CIA 18285	42 /140	CIA 18353	1 /140	CIA 18389	2 /140	CIA 18515	37 /140
CIA 18240	42 /140	CIA 18286	42 /140	CIA 18354	1 /140	CIA 18390	2 /140	CIA 18521	79 /140
CIA 18252	41 /140	CIA 18287	42 /140	CIA 18355	1 /140	CIA 18391	2 /140	CIA 18543	87 /140
CIA 18253	41 /140	CIA 18288	42 /140	CIA 18356	1 /140	CIA 18392	2 /140	CIA 18558	8 /140
CIA 18254	41 /140	CIA 18289	42 /140	CIA 18357	1 /140	CIA 18393	2 /140	CIA 18562	50 /140
CIA 18255	41 /140	CIA 18290	42 /140	CIA 18358	1 /140	CIA 18394	2 /140	CIA 18569	93 /140
CIA 18256	41 /140	CIA 18291	42 /140	CIA 18359	1 /140	CIA 18395	2 /140	CIA 18570	26 /140
CIA 18257	41 /140	CIA 18292	43 /140	CIA 18360	1 /140	CIA 18396	3 /140	CIA 18575	92 /140
CIA 18258	41 /140	CIA 18293	43 /140	CIA 18361	1 /140	CIA 18397	3 /140	CIA 18584	44 /140
CIA 18259	41 /140	CIA 18294	43 /140	CIA 18362	1 /140	CIA 18398	3 /140	CIA 18586	64 /140
CIA 18260	41 /140	CIA 18295	43 /140	CIA 18363	1 /140	CIA 18399	3 /140	CIA 18587	78 /140
CIA 18261	41 /140	CIA 18296	43 /140	CIA 18364	1 /140	CIA 18400	3 /140	CIA 18588	138 /140
CIA 18262	41 /140	CIA 18297	25 /140	CIA 18365	1 /140	CIA 18401	3 /140	CIA 18594	71 /140
CIA 18264	41 /140	CIA 18304	8 /140	CIA 18367	1 /140	CIA 18402	3 /140	CIA 18595	49 /140
CIA 18265	41 /140	CIA 18305	10 /140	CIA 18368	1 /140	CIA 18404	3 /140	CIA 18596	71 /140
CIA 18266	41 /140	CIA 18309	63 /140	CIA 18369	1 /140	CIA 18407	3 /140	CIA 18600	24 /140
CIA 18267	41 /140	CIA 18311	94 /140	CIA 18370	1 /140	CIA 18408	3 /140	CIA 18601	63 /140
CIA 18268	41 /140	CIA 18314	30 /140	CIA 18371	1 /140	CIA 18409	3 /140	CIA 18606	120 /140
CIA 18269	41 /140	CIA 18317	81 /140	CIA 18372	1 /140	CIA 18410	3 /140	CIA 18635	9 /140
CIA 18270	41 /140	CIA 18322	26 /140	CIA 18373	2 /140	CIA 18412	77 /140	CIA 18636	72 /140
CIA 18271	41 /140	CIA 18323	12 /140	CIA 18374	2 /140	CIA 18413	77 /140	CIA 18645	98 /140
CIA 18272	41 /140	CIA 18330	43 /140	CIA 18375	99 /140	CIA 18414	71 /140	CIA 18646	131 /140
CIA 18273	41 /140	CIA 18331	73 /140	CIA 18376	2 /140	CIA 18415	77 /140	CIA 18647	118 /140

CIA 18648	129 /140	CIA 18816	87 /140	CIA 19016	126 /140	CIA 19434	62 /140	CIA 19938	80 /140
CIA 18649	115 /140	CIA 18823	70 /140	CIA 19026	1 /140	CIA 19459	73 /140	CIA 19944	89 /140
CIA 18650	124 /140	CIA 18826	11 /140	CIA 19029	26 /140	CIA 19464	138 /140	CIA 19955	62 /140
CIA 18651	118 /140	CIA 18834	99 /140	CIA 19033	87 /140	CIA 19471	19 /140	CIA 19970	65 /140
CIA 18652	73 /140	CIA 18836	21 /140	CIA 19091	78 /140	CIA 19473	11 /140	CIA 19978	139 /140
CIA 18653	71 /140	CIA 18842	9 /140	CIA 19096	21 /140	CIA 19475	69 /140	CIA 19979	139 /140
CIA 18661	48 /140	CIA 18843	29 /140	CIA 19111	76 /140	CIA 19487	28 /140	CIA 19980	140 /140
CIA 18665	1 /140	CIA 18852	37 /140	CIA 19112	75 /140	CIA 19514	75 /140	CIA 19982	138 /140
CIA 18675	6 /140	CIA 18854	14 /140	CIA 19122	35 /140	CIA 19527	112 /140	CIA 20018	110 /140
CIA 18678	90 /140	CIA 18857	13 /140	CIA 19142	74 /140	CIA 19547	100 /140	CIA 20023	95 /140
CIA 18686	90 /140	CIA 18858	68 /140	CIA 19147	21 /140	CIA 19548	101 /140	CIA 20025	138 /140
CIA 18688	90 /140	CIA 18861	78 /140	CIA 19148	21 /140	CIA 19567	82 /140	CIA 20039	7 /140
CIA 18690	94 /140	CIA 18862	10 /140	CIA 19161	22 /140	CIA 19569	139 /140		
CIA 18697	71 /140	CIA 18868	76 /140	CIA 19164	72 /140	CIA 19585	73 /140		
CIA 18703	73 /140	CIA 18886	74 /140	CIA 19165	76 /140	CIA 19601	72 /140		
CIA 18715	14 /140	CIA 18909	27 /140	CIA 19172	28 /140	CIA 19606	105 /140		
CIA 18727	76 /140	CIA 18916	137 /140	CIA 19178	116 /140	CIA 19609	6 /140		
CIA 18728	52 /140	CIA 18918	87 /140	CIA 19214	1 /140	CIA 19619	76 /140		
CIA 18730	18 /140	CIA 18925	94 /140	CIA 19224	30 /140	CIA 19624	68 /140		
CIA 18734	46 /140	CIA 18955	71 /140	CIA 19237	109 /140	CIA 19717	55 /140		
CIA 18736	58 /140	CIA 18956	31 /140	CIA 19276	140 /140	CIA 19718	52 /140		
CIA 18755	90 /140	CIA 18967	129 /140	CIA 19293	16 /140	CIA 19818	137 /140		
CIA 18768	52 /140	CIA 18972	98 /140	CIA 19294	73 /140	CIA 19819	137 /140		
CIA 18769	29 /140	CIA 18980	15 /140	CIA 19303	18 /140	CIA 19878	139 /140		
CIA 18770	25 /140	CIA 18981	15 /140	CIA 19326	52 /140	CIA 19879	113 /140		
CIA 18771	25 /140	CIA 18984	100 /140	CIA 19329	79 /140	CIA 19881	78 /140		
CIA 18772	27 /140	CIA 18987	54 /140	CIA 19331	86 /140	CIA 19885	101 /140		
CIA 18797	64 /140	CIA 18988	58 /140	CIA 19351	91 /140	CIA 19888	104 /140		
CIA 18801	42 /140	CIA 18991	68 /140	CIA 19368	18 /140	CIA 19894	16 /140		
CIA 18803	9 /140	CIA 18993	109 /140	CIA 19378	68 /140	CIA 19899	139 /140		
CIA 18804	43 /140	CIA 19001	1 /140	CIA 19386	61 /140	CIA 19911	73 /140		
CIA 18805	71 /140	CIA 19006	1 /140	CIA 19390	4 /140	CIA 19925	93 /140		
CIA 18806	26 /140	CIA 19007	27 /140	CIA 19393	9 /140	CIA 19926	84 /140		
CIA 18815	64 /140	CIA 19011	27 /140	CIA 19433	95 /140	CIA 19932	9 /140		

PERFIL ESPONJOSO

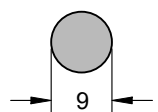
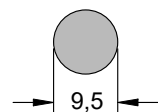
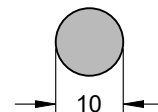
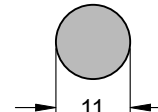
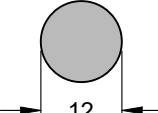
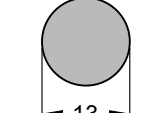
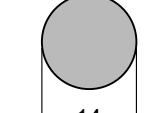
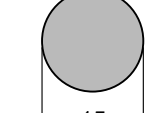
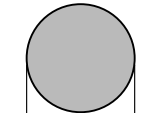
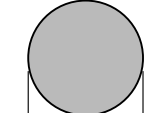
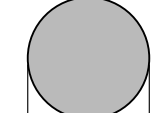
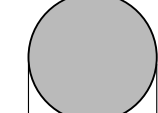
<p>CIA 18665 (EPDM 20 Shore A) CIA 19214 (SBR 15 Shore A)</p> 	<p>CIA 18345 (SBR 15 Shore A) CIA 18346 (SBR 10 Shore A) CIA 18347 (EPDM 10 Shore A)</p> 	<p>CIA 18348 (SBR 10 Shore A)</p> 	<p>CIA 18351 (SBR 10 Shore A) CIA 18352 (EPDM 10 Shore A) CIA 18353 (SBR 15 Shore A) CIA 18354 (EPDM 15 Shore A)</p> 
<p>CIA 18355 (SBR 10 Shore A) CIA 18356 (SBR 10 Shore A - Bege)</p> 	<p>CIA 18357 (SBR 10 Shore A) CIA 18358 (EPDM 15 Shore A) CIA 19006 (EPDM 10 Shore A)</p> 	<p>CIA 18335 (SBR 10 Shore A) CIA 18359 (SBR 30 Shore A) CIA 19001 (SBR 10 Shore A - Bege)</p> 	<p>CIA 18360 (SBR 30 Shore A - Bege)</p> 
<p>CIA 18361 (SBR 15 Shore A) CIA 18362 (SBR 10 Shore A - Bege)</p> 	<p>CIA 18363 (SBR 10 Shore A) CIA 18365 (SBR 30 Shore A - Bege)</p> 	<p>CIA 18364 (SBR 10 Shore A - Bege)</p> 	<p>CIA 18367 (SBR 30 Shore A - Bege)</p> 
<p>CIA 18368 (SBR 10 Shore A - Bege)</p> 	<p>CIA 18369 (SBR 10 Shore A) CIA 18370 (EPDM 10 Shore A)</p> 	<p>CIA 19026 (SBR 10 Shore A - Bege)</p> 	<p>CIA 18371 (SBR 10 Shore A) CIA 18372 (EPDM 10 Shore A)</p> 

PERFIL ESPONJOSO

<p>CIA 18373 (SBR 10 Shore A) CIA 18374 (EPDM 30 Shore A)</p> 	<p>CIA 18376 (SBR 10 Shore A)</p> 	<p>CIA 18377 (SBR 10 Shore A) CIA 18378 (SBR 30 Shore A)</p> 	<p>CIA 18379 (SBR 10 Shore A) CIA 18380 (SBR 15 Shore A)</p> 
<p>CIA 18381 (SBR 10 Shore A) CIA 18382 (SBR 30 Shore A)</p> 	<p>CIA 18383 (SBR 10 Shore A) CIA 17554 (EPDM 10 Shore A)</p> 	<p>CIA 18384 (SBR 10 Shore A)</p> 	<p>CIA 18386 (SBR 10 Shore A) CIA 18387 (SBR 30 Shore A)</p> 
<p>CIA 18336 (SBR 10 Shore A)</p> 	<p>CIA 18388 (SBR 30 Shore A) CIA 18389 (SBR 10 Shore A)</p> 	<p>CIA 18390 (SBR 10 Shore A)</p> 	<p>CIA 18391 (SBR 10 Shore A)</p> 
<p>CIA 18392 (SBR 10 Shore A)</p> 	<p>CIA 18393 (SBR 10 Shore A)</p> 	<p>CIA 18394 (SBR 10 Shore A)</p> 	<p>CIA 18395 (SBR 10 Shore A)</p> 

PERFIL ESPONJOSO

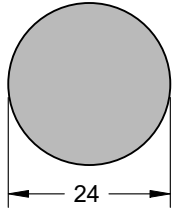
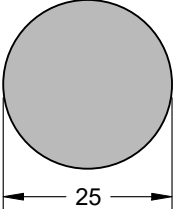
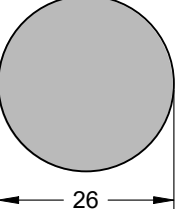
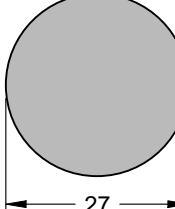
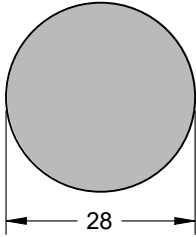
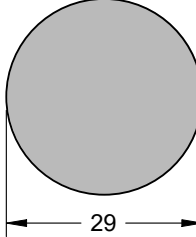
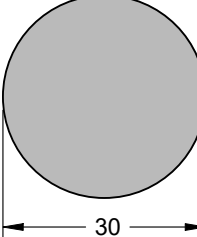
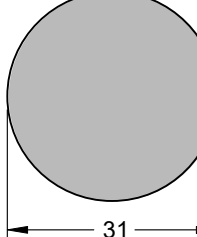
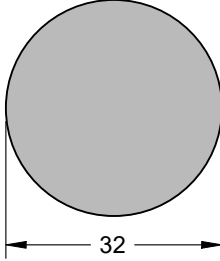
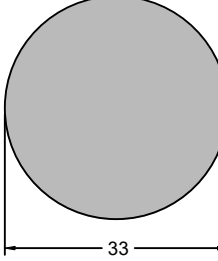
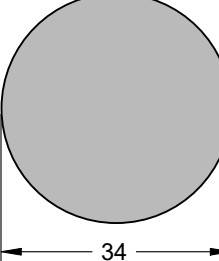
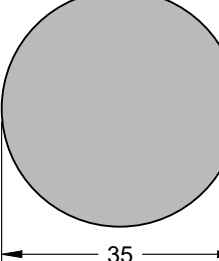
<p><i>CIA 18396 (SBR 10 Shore A)</i></p>  <p>24</p>	<p><i>CIA 18397 (SBR 10 Shore A)</i></p>  <p>25</p>	<p><i>CIA 18398 (SBR 10 Shore A)</i></p>  <p>26</p>	<p><i>CIA 18399 (SBR 10 Shore A)</i></p>  <p>27</p>
<p><i>CIA 18400 (SBR 10 Shore A)</i></p>  <p>28</p>	<p><i>CIA 18401 (SBR 10 Shore A)</i></p>  <p>29</p>	<p><i>CIA 18402 (SBR 10 Shore A)</i> <i>CIA 18502 (SBR 15 Shore A)</i></p>  <p>30</p>	<p><i>CIA 18404 (SBR 10 Shore A)</i></p>  <p>31</p>
<p><i>CIA 18407 (SBR 10 Shore A)</i></p>  <p>32</p>	<p><i>CIA 18408 (SBR 10 Shore A)</i></p>  <p>33</p>	<p><i>CIA 18409 (SBR 10 Shore A)</i></p>  <p>34</p>	<p><i>CIA 18410 (SBR 10 Shore A)</i></p>  <p>35</p>

PERFIL ESPONJOSO

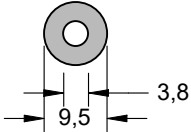
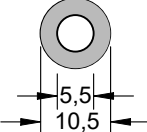
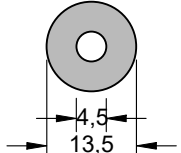
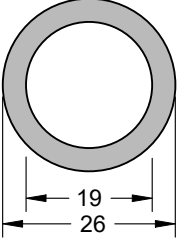
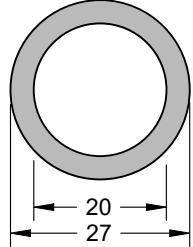
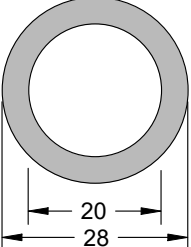
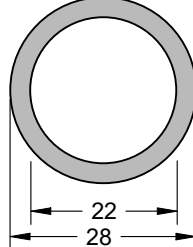
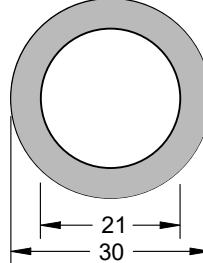
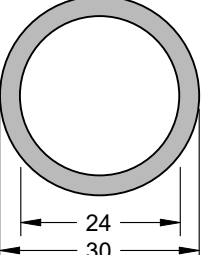
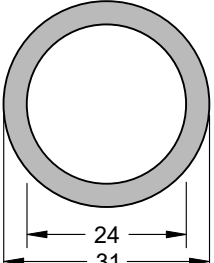
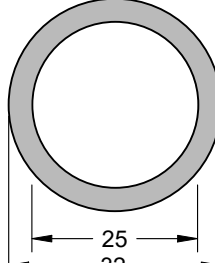
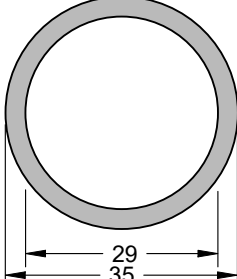
<p><i>CIA 4311 (EPDM 15 Shore A)</i></p> 	<p><i>CIA 19390 (EPDM 15 Shore A)</i></p> 	<p><i>CIA 17067 (EPDM 15 Shore A)</i></p> 	<p><i>CIA 18128 (EPDM 30 Shore A)</i></p> 
<p><i>CIA 16705 (EPDM 30 Shore A)</i></p> 	<p><i>CIA 4167 (SBR 10 Shore A)</i></p> 	<p><i>CIA 4299 (SBR 10 Shore A)</i></p> 	<p><i>CIA 4324 (SBR 10 Shore A)</i></p> 
<p><i>CIA 4285 (EPDM 30 Shore A)</i></p> 	<p><i>CIA 4317 (EPDM 30 Shore A)</i></p> 	<p><i>CIA 4122 (EPDM 30 Shore A)</i></p> 	<p><i>CIA 4411 (EPDM 30 Shore A)</i></p> 

PERFIL ESPONJOSO

CIA 4154 (EPDM 30 Shore A)

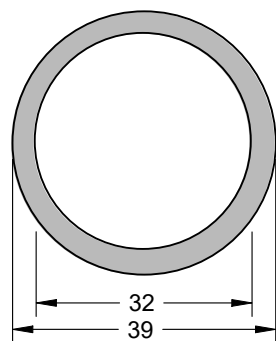

CIA 4298 (EPDM 30 Shore A)

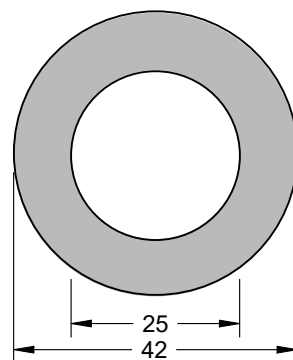

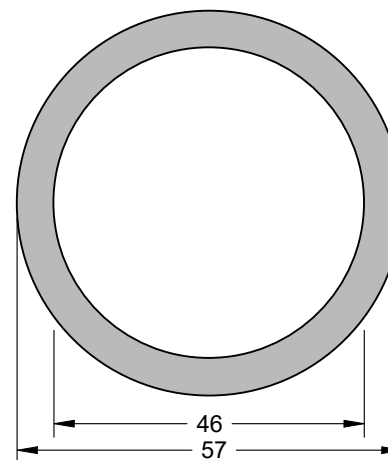

CIA 17664 (EPDM 30 Shore A)

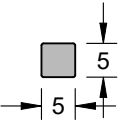
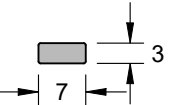
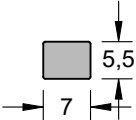
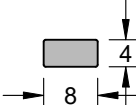
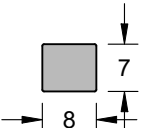
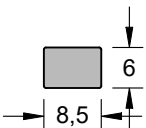
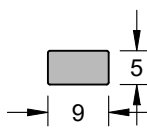
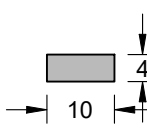
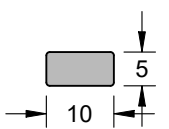
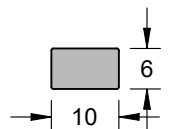
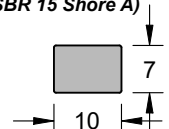
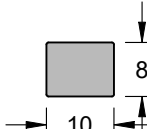
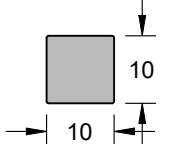
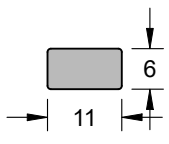
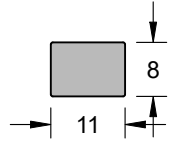
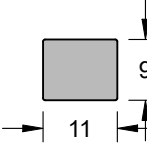

PERFIL ESPONJOSO

<p>CIA 15063 (EPDM 10 Shore A)</p> 	<p>CIA 4002 (SBR 10 Shore A) CIA 17063 (EPDM 45 Shore A)</p> 	<p>CIA 14556 (SBR 10 Shore A) CIA 16749 (SBR 15 Shore A)</p> 	<p>CIA 4103 (SBR 10 Shore A)</p> 
<p>CIA 18675 (EPDM 30 Shore A)</p> 	<p>CIA 16789 (EPDM 10 Shore A)</p> 	<p>CIA 4096 (SBR 10 Shore A)</p> 	<p>CIA 18060 (EPDM 10 Shore A)</p> 
<p>CIA 4266 (EPDM 10 Shore A - Bege)</p> 	<p>CIA 4003 (SBR 10 Shore A)</p> 	<p>CIA 4004 (SBR 10 Shore A) CIA 4343 (EPDM 10 Shore A) CIA 16774 (SBR 15 Shore A)</p> 	<p>CIA 4094 (SBR 10 Shore A)</p> 
<p>CIA 4080 (SBR 10 Shore A) CIA 4390 (EPDM 15 Shore A - Bege)</p> 	<p>CIA 14341 (EPDM 10 Shore A - Bege) CIA 19609 (EPDM 10 Shore A)</p> 	<p>CIA 4364 (EPDM 10 Shore A - Bege) CIA 4384 (EPDM 15 Shore A - Bege)</p> 	<p>CIA 4095 (SBR 10 Shore A)</p> 

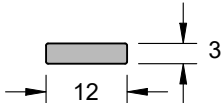
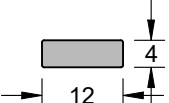
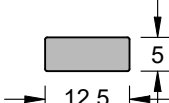
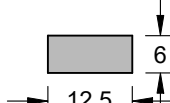
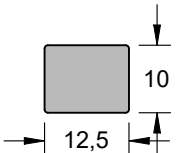
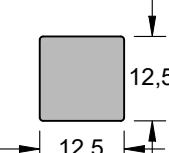
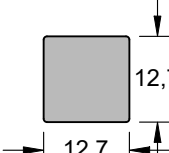
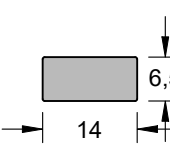
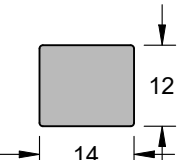
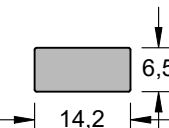
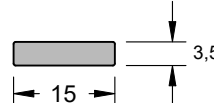

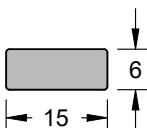
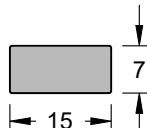
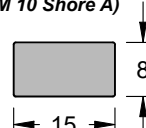
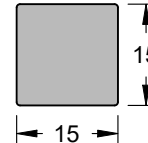

PERFIL ESPONJOSO

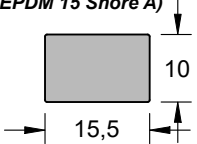
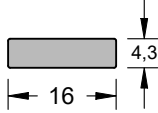
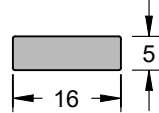
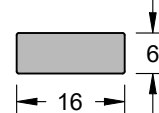
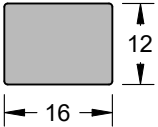
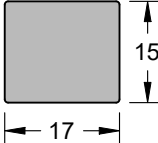
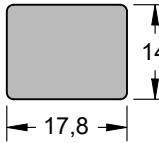
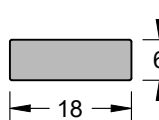
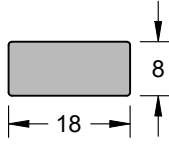
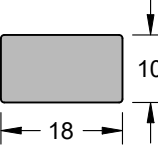
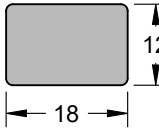
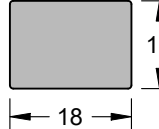
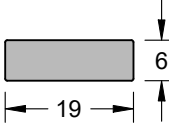
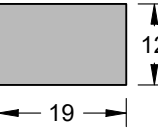
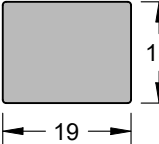
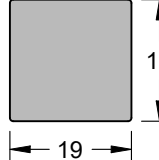
<p>CIA 4039 (SBR 10 Shore A)</p> 	<p>CIA 4072 (SBR 10 Shore A)</p> 	<p>CIA 4064 (SBR 10 Shore A) CIA 4347 (EPDM 10 Shore A)</p> 	<p>CIA 4331 (EPDM 10 Shore A)</p> 
<p>CIA 4087 (SBR 10 Shore A)</p> 	<p>CIA 4065 (SBR 10 Shore A)</p> 	<p>CIA 4155 (EPDM 10 Shore A)</p> 	<p>CIA 4100 (EPDM 30 Shore A)</p> 
<p>CIA 4144 (SBR 10 Shore A)</p> 	<p>CIA 4005 (SBR 10 Shore A) CIA 19991 (EPDM 10 Shore A)</p> 	<p>CIA 4014 (SBR 10 Shore A)</p> 	<p>CIA 4261 (EPDM 10 Shore A) CIA 4267 (EPDM 10 Shore A - Bege)</p> 
<p>CIA 4151 (SBR 10 Shore A) CIA 4395 (EPDM 30 Shore A)</p> 	<p>CIA 4192 (SBR 10 Shore A) CIA 20039 (NBR 10 Shore A)</p> 	<p>CIA 4018 (SBR 10 Shore A) CIA 4280 (SBR 15 Shore A) CIA 4378 (EPDM 10 Shore A)</p> 	<p>CIA 4016 (SBR 10 Shore A)</p> 

PERFIL ESPONJOSO

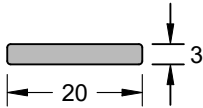
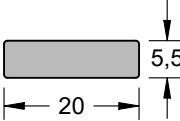
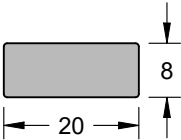
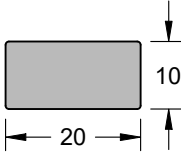
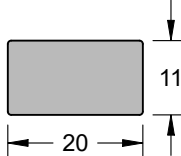
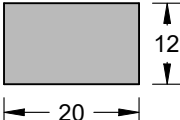
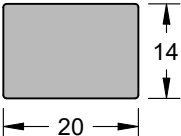
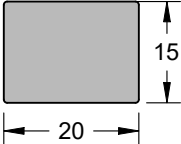
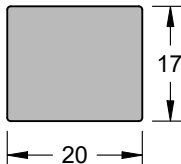
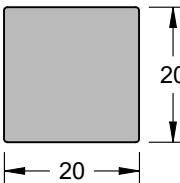
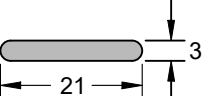
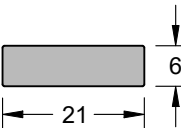
<p>CIA 4017 (SBR 10 Shore A) CIA 16656 (EPDM 10 Shore A) CIA 18514 (EPDM 15 Shore A)</p> 	<p>CIA 4019 (SBR 10 Shore A)</p> 	<p>CIA 4164 (SBR 10 Shore A)</p> 	<p>CIA 4200 (SBR 10 Shore A)</p> 
<p>CIA 4097 (SBR 10 Shore A)</p> 	<p>CIA 4022 (SBR 10 Shore A)</p> 	<p>CIA 4074 (SBR 15 Shore A)</p> 	<p>CIA 4146 (EPDM 15 Shore A) CIA 16833 (EPDM 10 Shore A)</p> 
<p>CIA 4020 (SBR 10 Shore A)</p> 	<p>CIA 4021 (SBR 10 Shore A) CIA 4073 (SBR 30 Shore A)</p> 	<p>CIA 16568 (EPDM 10 Shore A)</p> 	<p>CIA 4006 (SBR 10 Shore A)</p> 
<p>CIA 4007 (SBR 10 Shore A) CIA 4234 (SBR 10 Shore A - Bege)</p> 	<p>CIA 18304 (SBR 15 Shore A)</p> 	<p>CIA 4023 (SBR 10 Shore A)</p> 	<p>CIA 18558 (EPDM 15 Shore A)</p> 

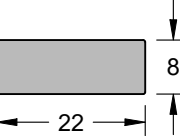
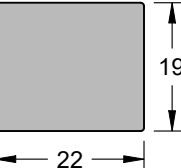

PERFIL ESPONJOSO

<p>CIA 15814 (EPDM 15 Shore A - Bege)</p> 	<p>CIA 4069 (SBR 10 Shore A)</p> 	<p>CIA 4024 (SBR 10 Shore A)</p> 	<p>CIA 4026 (SBR 10 Shore A) CIA 4246 (SBR 15 Shore A)</p> 
<p>CIA 16844 (SBR 30 Shore A) CIA 19932 (SBR 10 Shore A)</p> 	<p>CIA 4337 (EPDM 10 Shore A - Bege) CIA 18803 (EPDM 10 Shore A)</p> 	<p>CIA 4083 (SBR 10 Shore A)</p> 	<p>CIA 19393 (EPDM 10 Shore A)</p> 
<p>CIA 4399 (SBR 10 Shore A)</p> 	<p>CIA 4025 (SBR 10 Shore A)</p> 	<p>CIA 18635 (EPDM 10 Shore A)</p> 	<p>CIA 18842 (EPDM 10 Shore A)</p> 
<p>CIA 4130 (SBR 10 Shore A)</p> 	<p>CIA 4038 (SBR 10 Shore A)</p> 	<p>CIA 4027 (SBR 10 Shore A) CIA 4101 (EPDM 10 Shore A)</p> 	<p>CIA 4264 (SBR 10 Shore A)</p> 

PERFIL ESPONJOSO

<p>CIA 18862 (EPDM 15 Shore A)</p>	<p>CIA 4402 (SBR 10 Shore A)</p>	<p>CIA 18305 (EPDM 15 Shore A)</p>	<p>CIA 17372 (SBR 10 Shore A)</p>
<p>CIA 16602 (EPDM 15 Shore A)</p>	<p>CIA 4028 (SBR 10 Shore A) CIA 4358 (EPDM 10 Shore A)</p>	<p>CIA 4077 (SBR 10 Shore A) CIA 17696 (EPDM 15 Shore A - Bege)</p>	<p>CIA 4008 (SBR 10 Shore A)</p>
<p>CIA 16859 (EPDM 15 Shore A)</p>	<p>CIA 4141 (EPDM 15 Shore A - Bege) CIA 4232 (SBR 10 Shore A)</p>	<p>CIA 4288 (SBR 10 Shore A)</p>	<p>CIA 4277 (SBR 10 Shore A)</p>
<p>CIA 4236 (CR 10 Shore A)</p>	<p>CIA 4070 (SBR 10 Shore A)</p>	<p>CIA 4009 (SBR 10 Shore A)</p>	<p>CIA 4081 (SBR 10 Shore A)</p>

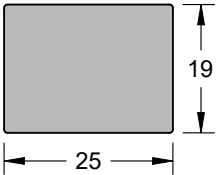
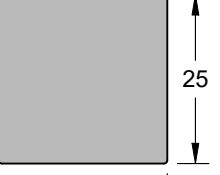
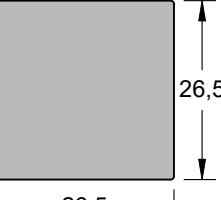
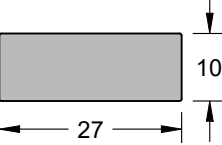
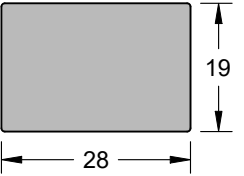
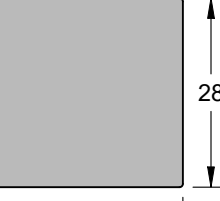
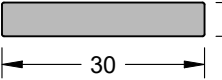
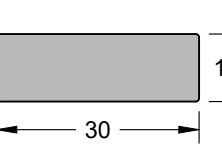
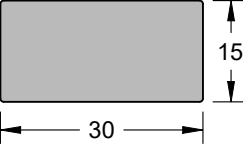
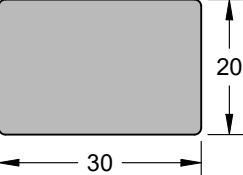
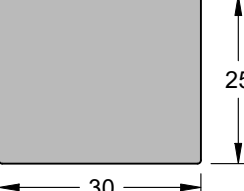
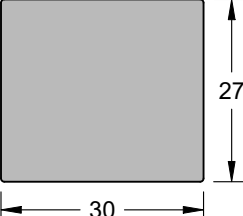
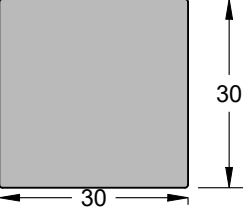
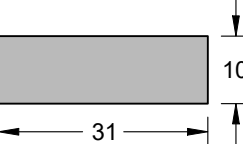

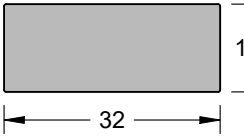

PERFIL ESPONJOSO

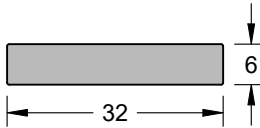
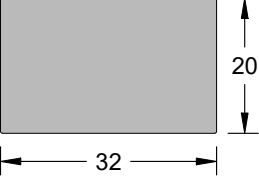
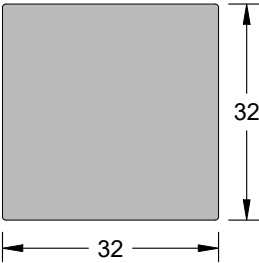
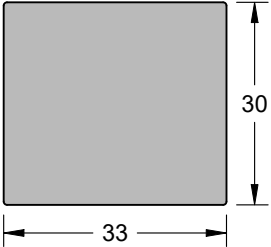
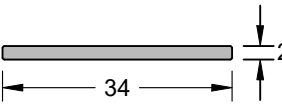
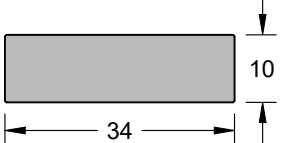
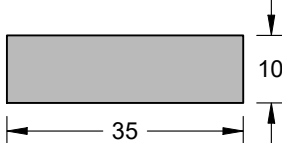
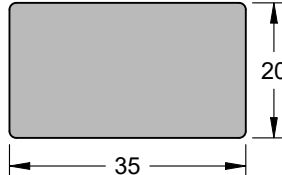
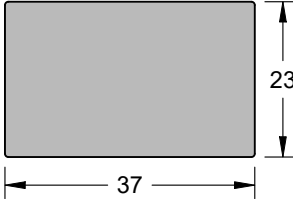
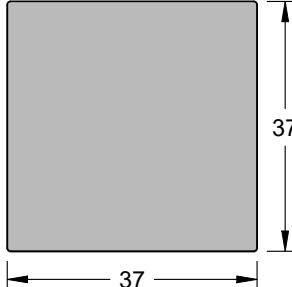
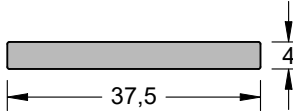
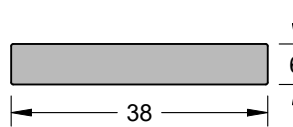
<p>CIA 4031 (SBR 10 Shore A) CIA 16599 (EPDM 15 Shore A)</p> 	<p>CIA 4029 (SBR 10 Shore A) CIA 4208 (SBR 30 Shore A)</p> 	<p>CIA 19473 (SBR 10 Shore A)</p> 	<p>CIA 4397 (EPDM 10 Shore A)</p> 
<p>CIA 4030 (SBR 10 Shore A)</p> 	<p>CIA 4068 (SBR 10 Shore A)</p> 	<p>CIA 4079 (SBR 10 Shore A)</p> 	<p>CIA 17431 (SBR 10 Shore A)</p> 
<p>CIA 4132 (SBR 10 Shore A) CIA 17058 (EPDM 15 Shore A)</p> 	<p>CIA 17873 (SBR 10 Shore A)</p> 	<p>CIA 4102 (SBR 10 Shore A) CIA 4353 (SBR 15 Shore A)</p> 	<p>CIA 4335 (SBR 10 Shore A)</p> 
<p>CIA 4150 (SBR 10 Shore A) CIA 4300 (SBR 30 Shore A)</p> 	<p>CIA 18826 (SBR 15 Shore A)</p> 	<p>CIA 4033 (SBR 10 Shore A)</p> 	<p>CIA 4140 (SBR 10 Shore A)</p> 

PERFIL ESPONJOSO

<p><i>CIA 4032 (SBR 10 Shore A)</i></p> 	<p><i>CIA 4221 (SBR 10 Shore A)</i></p> 	<p><i>CIA 17867 (EPDM 15 Shore A)</i></p> 	<p><i>CIA 4410 (SBR 15 shore A)</i></p> 
<p><i>CIA 4129 (EPDM 10 Shore A)</i></p> 	<p><i>CIA 4398 (EPDM 10 Shore A)</i></p> 	<p><i>CIA 4409 (EPDM 10 Shore A)</i></p> 	<p><i>CIA 18323 (SBR 10 Shore A)</i></p> 
<p><i>CIA 4408 (SBR 10 Shore A)</i></p> 	<p><i>CIA 17376 (EPDM 15 Shore A)</i></p> 	<p><i>CIA 4034 (SBR 10 Shore A)</i></p> 	<p><i>CIA 4035 (SBR 10 Shore A)</i> <i>CIA 4242 (SBR 10 Shore A - Bege)</i></p> 

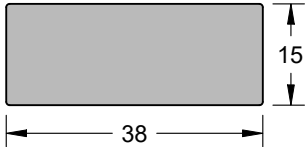
PERFIL ESPONJOSO

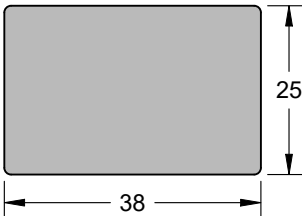
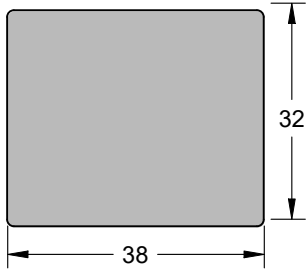
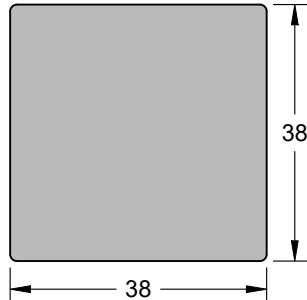
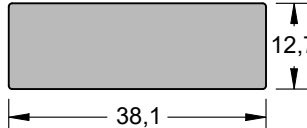
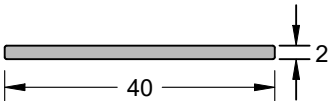
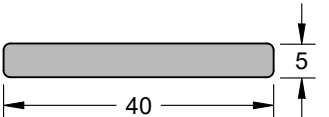
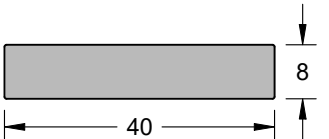
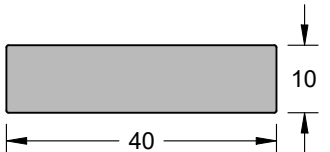
<p>CIA 4063 (SBR 10 Shore A)</p> 	<p>CIA 4250 (NBR 30 Shore A)</p> 	<p>CIA 4075 (SBR 10 Shore A) CIA 18857 (EPDM 20 Shore A)</p> 	<p>CIA 4255 (SBR 10 Shore A) CIA 18061 (EPDM 10 Shore A)</p> 
<p>CIA 18417 (EPDM 10 Shore A)</p> 	<p>CIA 4363 (SBR 15 Shore A)</p> 	<p>CIA 4362 (SBR 15 Shore A) CIA 4389 (SBR 10 Shore A)</p> 	<p>CIA 16768 (SBR 10 Shore A)</p> 
<p>CIA 4124 (SBR 10 Shore A)</p> 	<p>CIA 17874 (SBR 10 Shore A)</p> 	<p>CIA 4149 (SBR 10 Shore A)</p> 	<p>CIA 4012 (SBR 10 Shore A)</p> 

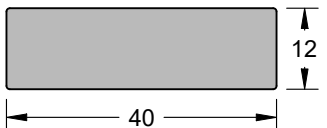
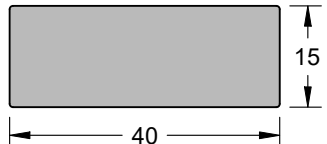
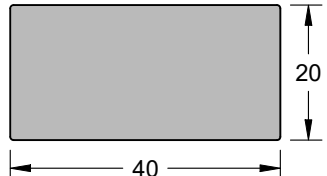
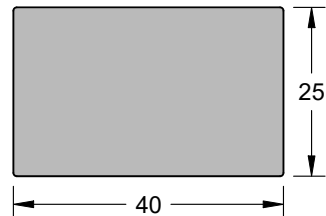
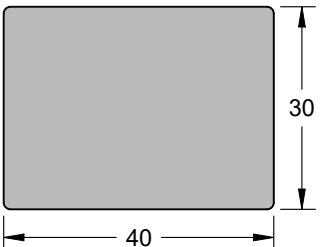
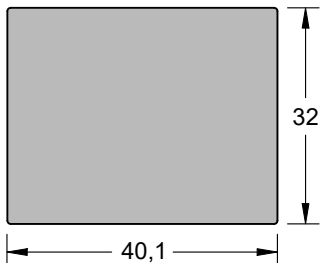
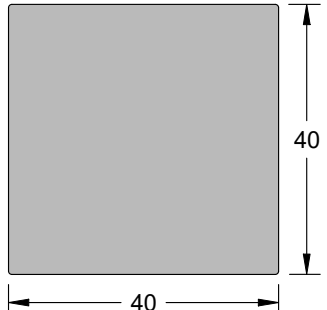
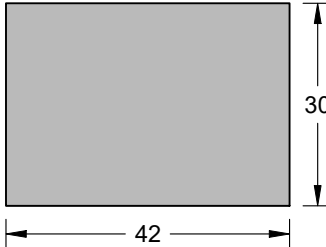
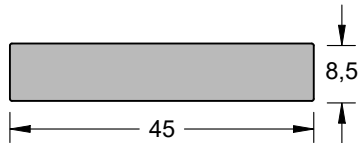
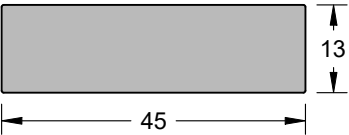
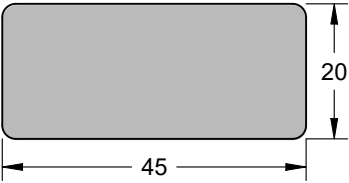
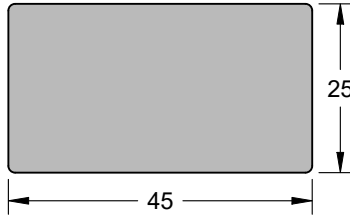

PERFIL ESPONJOSO

<p>CIA 4011 (SBR 10 Shore A) CIA 18854 (EPDM 30 Shore A)</p> 	<p>CIA 4403 (SBR 10 Shore A)</p> 	<p>CIA 4010 (SBR 10 Shore A) CIA 15169 (EPDM 10 Shore A)</p> 	<p>CIA 4224 (SBR 10 Shore A)</p> 
<p>CIA 17697 (EPDM 15 Shore A) CIA 17848 (SBR 10 Shore A)</p> 	<p>CIA 4126 (SBR 10 Shore A)</p> 	<p>CIA 4135 (SBR 10 Shore A)</p> 	<p>CIA 18480 (EPDM 15 Shore A)</p> 
<p>CIA 4013 (SBR 10 Shore A)</p> 	<p>CIA 4191 (SBR 10 Shore A)</p> 	<p>CIA 16653 (SBR 35 Shore A)</p> 	<p>CIA 18715 (SBR 10 Shore A)</p> 

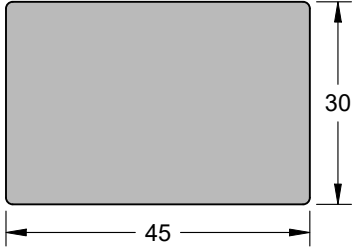
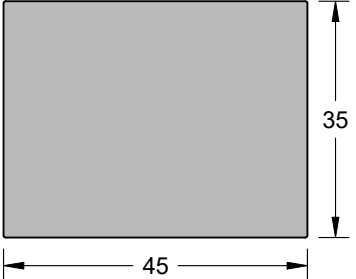
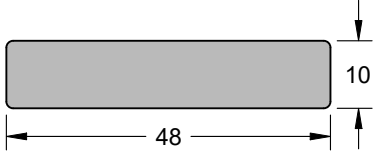
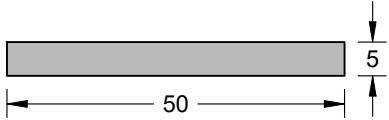
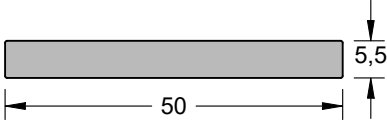
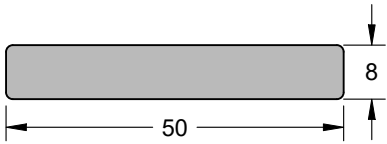
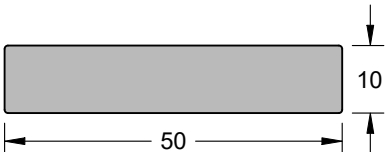
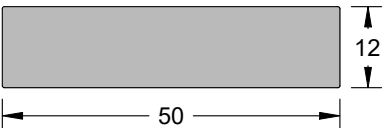
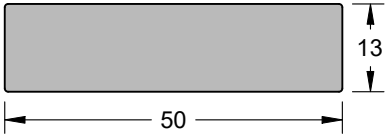
PERFIL ESPONJOSO

<p><i>CIA 4118 (SBR 10 Shore A)</i></p> 	<p><i>CIA 4181 (SBR 10 Shore A)</i></p> 	<p><i>CIA 4259 (SBR 10 Shore A)</i></p> 
<p><i>CIA 17570 (EPDM 30 Shore A)</i></p> 	<p><i>CIA 4036 (SBR 10 Shore A)</i> <i>CIA 4186 (SBR 15 Shore A)</i> <i>CIA 16961 (NBR 10 Shore A)</i></p> 	<p><i>CIA 4240 (SBR 10 Shore A)</i></p> 
<p><i>CIA 4276 (SBR 10 Shore A)</i> <i>CIA 18981 (EPDM 15 Shore A)</i></p> 	<p><i>CIA 4176 (SBR 10 Shore A)</i> <i>CIA 18980 (EPDM 15 Shore A)</i></p> 	<p><i>CIA 16569 (EPDM 30 Shore A)</i></p> 

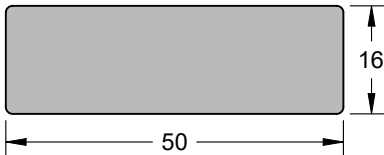
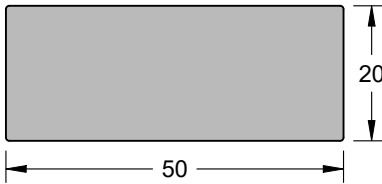
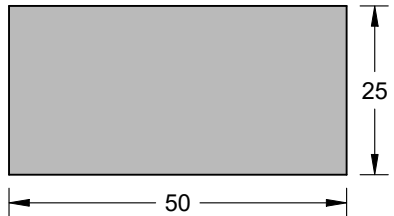
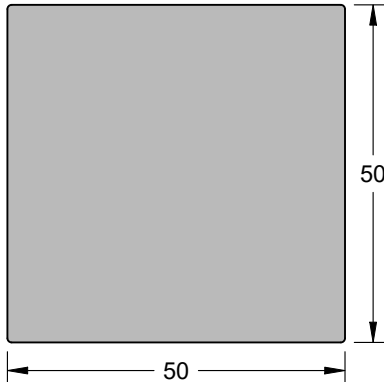
PERFIL ESPONJOSO

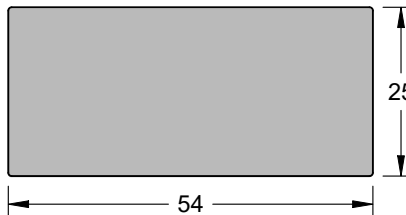
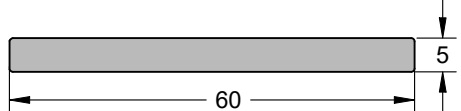
<p><i>CIA 17202 (SBR 10 Shore A)</i></p> 	<p><i>CIA 4152 (SBR 10 Shore A)</i></p> 	<p><i>CIA 4342 (SBR 10 Shore A)</i></p> 
<p><i>CIA 19894 (EPDM 10 Shore A)</i></p> 	<p><i>CIA 4040 (SBR 10 Shore A)</i></p> 	<p><i>CIA 4037 (SBR 10 Shore A)</i> <i>CIA 4076 (EPDM 10 Shore A)</i></p> 
	<p><i>CIA 4082 (EPDM 10 Shore A)</i> <i>CIA 4089 (SBR 10 Shore A)</i></p> 	<p><i>CIA 19293 (EPDM 45 Shore A)</i></p> 

PERFIL ESPONJOSO

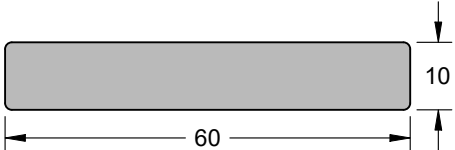
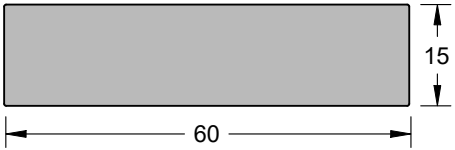
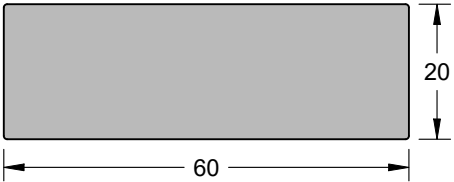
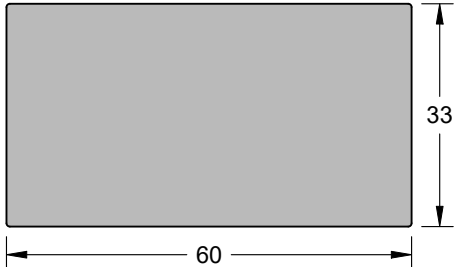
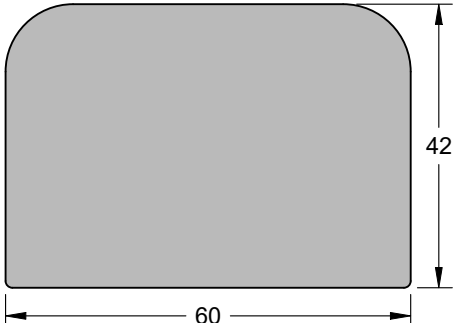
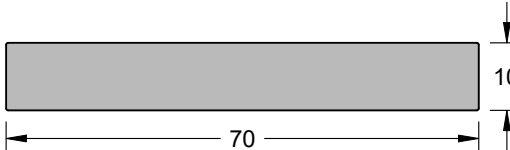
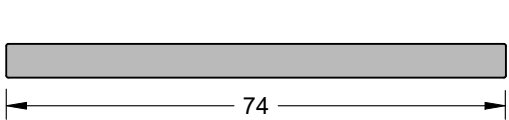
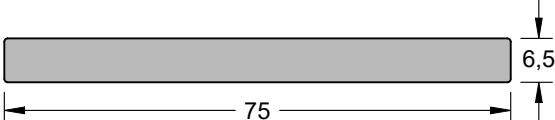
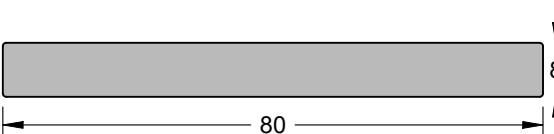
<p><i>CIA 4289 (SBR 10 Shore A)</i></p> 	<p><i>CIA 4196 (SBR 10 Shore A)</i></p> 	<p><i>CIA 4214 (SBR 10 Shore A)</i></p> 
<p><i>CIA 4119 (SBR 15 Shore A)</i></p> 	<p><i>CIA 4182 (SBR 10 Shore A)</i></p> 	<p><i>CIA 4197 (SBR 10 Shore A)</i></p> 
<p><i>CIA 4198 (SBR 10 Shore A)</i></p> 	<p><i>CIA 4041 (SBR 10 Shore A)</i></p> 	<p><i>CIA 4203 (SBR 30 Shore A)</i></p> 

PERFIL ESPONJOSO

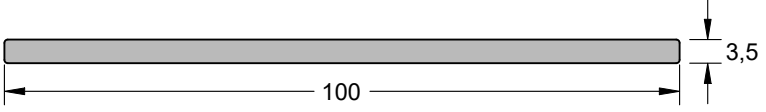
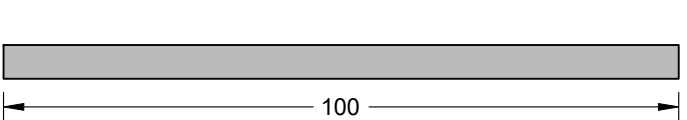
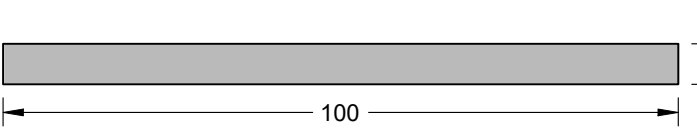
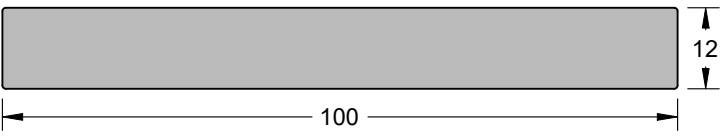
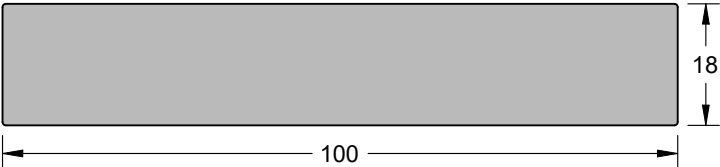
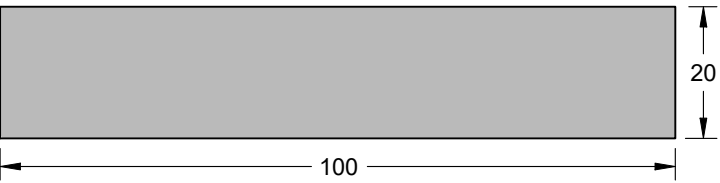
<p>CIA 18730 (EPDM 15 Shore A) CIA 19368 (EPDM 30 Shore A)</p>  <p>Technical drawing of a rectangular foam profile with a length of 100 mm and a thickness of 3.5 mm. The drawing includes dimension lines and arrows indicating the measurements.</p>	<p>CIA 19303 (EPDM 45 Shore A)</p>  <p>Technical drawing of a rectangular foam profile with a length of 100 mm and a thickness of 5 mm. The drawing includes dimension lines and arrows indicating the measurements.</p>
<p>CIA 4344 (EPDM 15 Shore A)</p>  <p>Technical drawing of a rectangular foam profile with a length of 100 mm and a thickness of 6 mm. The drawing includes dimension lines and arrows indicating the measurements.</p>	<p>CIA 4147 (SBR 15 Shore A)</p>  <p>Technical drawing of a rectangular foam profile with a length of 100 mm and a thickness of 12 mm. The drawing includes dimension lines and arrows indicating the measurements.</p>
<p>CIA 16591 (SBR 10 Shore A)</p>  <p>Technical drawing of a rectangular foam profile with a length of 100 mm and a thickness of 18 mm. The drawing includes dimension lines and arrows indicating the measurements.</p>	<p>CIA 16992 (SBR 10 Shore A)</p>  <p>Technical drawing of a rectangular foam profile with a length of 100 mm and a thickness of 20 mm. The drawing includes dimension lines and arrows indicating the measurements.</p>

PERFIL ESPONJOSO

<p>CIA 4359 (SBR 15 Shore A)</p>		<p>CIA 19471 (EPDM 15 Shore A)</p>	
<p>CIA 4142 (SBR 10 Shore A)</p>		<p>CIA 4287 (SBR 10 Shore A)</p>	<p>CIA 4265 (EPDM 15 Shore A)</p>
<p>CIA 4168 (SBR 10 Shore A)</p>	<p>CIA 4188 (SBR 10 Shore A)</p>	<p>CIA 4053 (SBR 10 Shore A)</p>	<p>CIA 4328 (CR 10 Shore A)</p>
<p>CIA 4213 (EPDM 10 Shore A)</p>	<p>CIA 14251 (EPDM 15 Shore A)</p>	<p>CIA 4268 (SBR 30 Shore A)</p>	<p>CIA 4247 (EPDM 10 Shore A)</p>

PERFIL ESPONJOSO

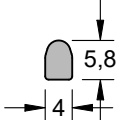
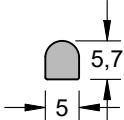
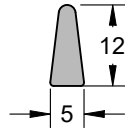
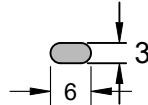
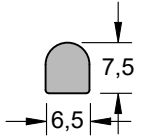
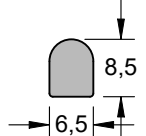
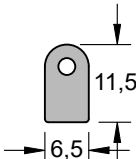
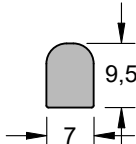
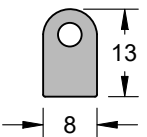
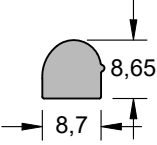
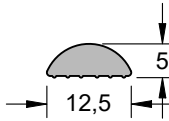
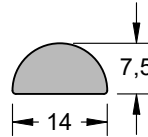
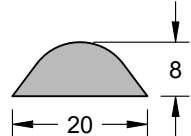
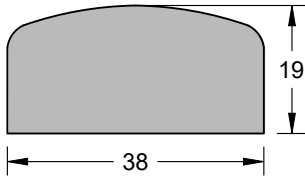
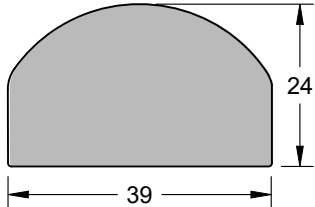
<p><i>CIA 4248 (EPDM 10 Shore A)</i></p> 	<p><i>CIA 4156 (EPDM 10 Shore A)</i></p> 	<p><i>CIA 4125 (EPDM 10 Shore A)</i></p> 	<p><i>CIA 4295 (SBR 30 Shore A)</i></p> 
<p><i>CIA 4253 (EPDM 10 Shore A)</i></p> 	<p><i>CIA 4262 (EPDM 10 Shore A)</i></p> 	<p><i>CIA 4307 (SBR 15 Shore A)</i></p> 	<p><i>CIA 4163 (SBR 10 Shore A)</i></p> 
<p><i>CIA 4136 (SBR 15 Shore A)</i></p> 	<p><i>CIA 4333 (EPDM 15 Shore A - Bege)</i></p> 	<p><i>CIA 4245 (SBR 30 Shore A)</i></p> 	<p><i>CIA 4392 (EPDM 15 Shore A)</i></p> 
<p><i>CIA 4351 (EPDM 30 Shore A)</i></p> 	<p><i>CIA 4001 (SBR 10 Shore A)</i></p> 		<p><i>CIA 4098 (SBR 10 Shore A)</i></p> 

PERFIL ESPONJOSO

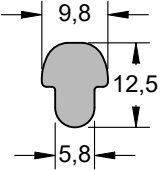
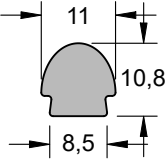
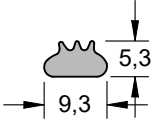
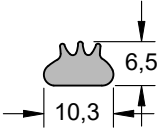
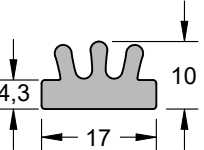
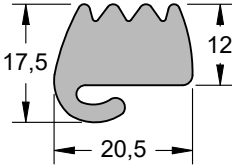
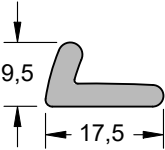
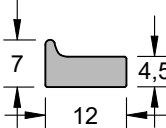
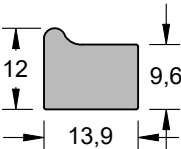
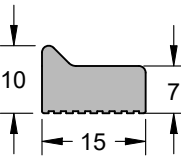
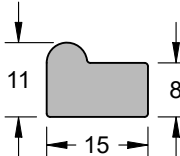
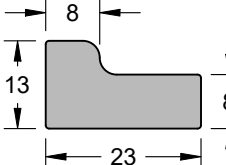
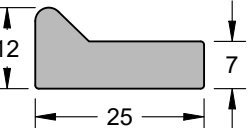
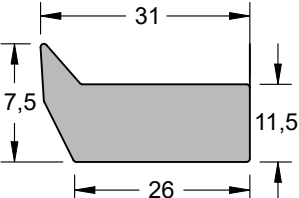
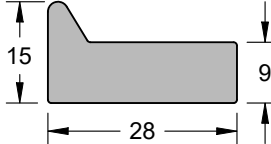
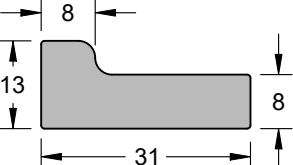
<p>CIA 4215 (EPDM 15 Shore A - Bege)</p> 	<p>CIA 4263 (SBR 10 Shore A)</p> 	<p>CIA 4185 (EPDM 15 Shore A)</p> 	<p>CIA 4184 (EPDM 15 Shore A)</p> 
<p>CIA 4241 (SBR 10 Shore A)</p> 	<p>CIA 4271 (EPDM 10 Shore A)</p> 	<p>CIA 4370 (EPDM 15 Shore A)</p> 	<p>CIA 4134 (SBR 10 Shore A)</p> 
<p>CIA 4062 (SBR 10 Shore A)</p> 	<p>CIA 4055 (SBR 10 Shore A)</p> 	<p>CIA 4193 (EPDM 10 Shore A)</p> 	<p>CIA 19148 (EPDM 15 Shore A)</p> 
<p>CIA 16787 (EPDM 10 Shore A)</p> 	<p>CIA 18836 (EPDM 10 Shore A) CIA 19096 (EPDM 15 Shore A)</p> 	<p>CIA 4357 (SBR 15 Shore A)</p> 	<p>CIA 19147 (EPDM 15 Shore A)</p> 

PERFIL ESPONJOSO

<p>CIA 16081 (SBR 10 Shore A)</p>	<p>CIA 19161 (EPDM 10 Shore A)</p>	<p>CIA 4153 (EPDM 15 Shore A)</p>	<p>CIA 16780 (EPDM 10 Shore A)</p>
<p>CIA 4306 (EPDM 10 Shore A)</p>	<p>CIA 4340 (EPDM 15 Shore A)</p>	<p>CIA 4175 (EPDM 15 Shore A)</p>	<p>CIA 14851 (EPDM 15 Shore A)</p>
<p>CIA 16964 (EPDM 15 Shore A)</p>	<p>CIA 4235 (EPDM 10 Shore A)</p>	<p>CIA 16688 (EPDM 10 Shore A)</p>	<p>CIA 16658 (EPDM 10 Shore A)</p>
<p>CIA 4308 (SBR 10 Shore A)</p>	<p>CIA 4195 (SBR 15 Shore A)</p>	<p>CIA 4054 (SBR 10 Shore A)</p>	<p>CIA 4225 (SBR 10 Shore A)</p>

PERFIL ESPONJOSO

<p><i>CIA 4401 (EPDM 15 Shore A)</i></p>	<p><i>CIA 4111 (SBR 10 Shore A)</i></p>	<p><i>CIA 4316 (EPDM 15 Shore A)</i></p>	<p><i>CIA 4110 (SBR 10 Shore A)</i></p>
<p><i>CIA 14320 (NBR 20 Shore A)</i></p>	<p><i>CIA 4251 (SBR 15 Shore A)</i></p>	<p><i>CIA 4169 (SBR 10 Shore A)</i></p>	
<p><i>CIA 16998 (EPDM 10 Shore A)</i></p>	<p><i>CIA 4216 (EPDM 10 Shore A)</i></p>	<p><i>CIA 4249 (SBR 30 Shore A)</i></p>	

PERFIL ESPONJOSO

<p><i>CIA 4204 (SBR 10 Shore A)</i></p>		<p><i>CIA 4219 (SBR 15 Shore A)</i></p>	
<p><i>CIA 4171 (EPDM 10 Shore A)</i></p>	<p><i>CIA 4226 (EPDM 10 Shore A)</i></p>	<p><i>CIA 4078 (EPDM 15 Shore A)</i></p>	<p><i>CIA 4412 (EPDM 15 Shore A)</i></p>
<p><i>CIA 16741 (EPDM 15 Shore A)</i></p>	<p><i>CIA 4206 (EPDM 10 Shore A)</i></p>	<p><i>CIA 4084 (EPDM 15 Shore A)</i></p>	<p><i>CIA 18600 (EPDM 15 Shore A)</i></p>

PERFIL ESPONJOSO

<p><i>CIA 4323 (EPDM 15 Shore A)</i></p>	<p><i>CIA 4238 (SBR 15 Shore A)</i></p>	<p><i>CIA 18343 (EPDM 20 Shore A)</i></p>	<p><i>CIA 4189 (EPDM 15 Shore A)</i></p>
<p><i>CIA 4345 (SBR 15 Shore A)</i></p>	<p><i>CIA 18770 (EPDM 20 Shore A)</i></p>	<p><i>CIA 4157 (SBR 15 Shore A)</i></p>	<p><i>CIA 4341 (EPDM 10 Shore A)</i> <i>CIA 16866 (EPDM 15 Shore A)</i></p>
<p><i>CIA 18297 (EPDM 30 Shore A)</i></p>	<p><i>CIA 4315 (EPDM 10 Shore A)</i> <i>CIA 15937 (EPDM15 Shore A)</i></p>	<p><i>CIA 17895 (EPDM 20 Shore A)</i></p>	<p><i>CIA 18771 (EPDM 20 Shore A)</i></p>
<p><i>CIA 4377 (SBR 30 Shore A)</i></p>	<p><i>CIA 4202 (SBR 15 Shore A)</i></p>	<p><i>CIA 4158 (EPDM 15 Shore A)</i></p>	<p><i>CIA 4117 (EPDM 10 Shore A)</i></p>

PERFIL ESPONJOSO

<p>CIA 4374 (SBR 15 Shore A)</p>	<p>CIA 18570 (EPDM 10 Shore A)</p>	<p>CIA 17134 (EPDM 20 Shore A)</p>	<p>CIA 4199 (EPDM 20 Shore A)</p>
<p>CIA 4312 (EPDM 15 Shore A)</p>	<p>CIA 16665 (EPDM 10 Shore A)</p>	<p>CIA 18806 (EPDM 10 Shore A)</p>	<p>CIA 16379 (EPDM 15 Shore A)</p>
<p>CIA 17437 (EPDM 15 Shore A)</p>	<p>CIA 4233 (EPDM 15 Shore A)</p>	<p>CIA 4320 (EPDM 15 Shore A)</p>	<p>CIA 4286 (EPDM 15 Shore A)</p>
<p>CIA 18322 (EPDM 15 Shore A)</p>	<p>CIA 17942 (EPDM 10 Shore A)</p>	<p>CIA 19029 (EPDM 20 Shore A)</p>	<p>CIA 4109 (SBR 15 Shore A)</p>

PERFIL ESPONJOSO

<p>CIA 4116 (SBR 15 Shore A)</p>	<p>CIA 4145 (EPDM 30 Shore A)</p>	<p>CIA 17959 (EPDM 30 Shore A)</p>	<p>CIA 18772 (EPDM 20 Shore A)</p>
<p>CIA 4310 (EPDM 10 Shore A - Bege)</p>	<p>CIA 4052 (SBR 30 Shore A) CIA 4332 (EPDM 15 Shore A - Bege)</p>	<p>CIA 15456 (EPDM 30 Shore A)</p>	<p>CIA 4373 (SBR 15 Shore A)</p>
<p>CIA 17548 (EPDM 20 Shore A)</p>	<p>CIA 19007 (EPDM 20 Shore A)</p>	<p>CIA 16674 (EPDM 30 Shore A)</p>	<p>CIA 4352 (EPDM 15 Shore A)</p>
<p>CIA 18909 (EPDM 20 Shore A)</p>	<p>CIA 19011 (EPDM 20 Shore A)</p>	<p>CIA 17861 (EPDM 15 Shore A)</p>	<p>CIA 18084 (EPDM 10 Shore A)</p>

PERFIL ESPONJOSO

<p><i>CIA 17246 (EPDM 30 Shore A)</i></p>	<p><i>CIA 16552 (EPDM 30 Shore A)</i></p>	<p><i>CIA 4137 (EPDM 10 Shore A)</i></p>	<p><i>CIA 19172 (EPDM 15 Shore A)</i></p>
<p><i>CIA 18175 (EPDM 15 Shore A)</i></p>	<p><i>CIA 17943 (EPDM 15 Shore A)</i></p>	<p><i>CIA 19487 (EPDM 15 Shore A)</i></p>	<p><i>CIA 4258 (SBR 10 Shore A)</i></p>
<p><i>CIA 4056 (SBR 10 Shore A)</i></p>	<p><i>CIA 16440 (EPDM 15 Shore A)</i></p>	<p><i>CIA 4303 (SBR 15 ShoreA)</i></p>	<p><i>CIA 4159 (SBR 15 Shore A)</i></p>
<p><i>CIA 4239 (SBR 10 Shore A)</i></p>	<p><i>CIA 4067 (SBR 10 Shore A)</i></p>	<p><i>CIA 4121 (EPDM 15 Shore A)</i></p>	<p><i>CIA 16641 (EPDM 10 Shore A)</i></p>

PERFIL ESPONJOSO

<p><i>CIA 16592 (SBR 10 Shore A)</i></p>	<p><i>CIA 4413 (EPDM 30 Shore A)</i></p>	<p><i>CIA 4139 (EPDM 10 Shore A)</i></p>	<p><i>CIA 17852 (EPDM 10 Shore A)</i></p>
<p><i>CIA 18769 (EPDM 15 Shore A)</i></p>	<p><i>CIA 17694 (EPDM 10 Shore A)</i></p>	<p><i>CIA 18843 (EPDM 10 Shore A)</i></p>	<p><i>CIA 17741 (SBR 15 Shore A)</i></p>
<p><i>CIA 17853 (EPDM 10 Shore A)</i></p>	<p><i>CIA 4349 (EPDM 15 Shore A)</i></p>	<p><i>CIA 15379 (EPDM 15 Shore A)</i></p>	<p><i>CIA 4113 (SBR 10 Shore A)</i></p>
<p><i>CIA 15895 (EPDM 15 Shore A)</i></p>	<p><i>CIA 4406 (EPDM 15 Shore A)</i></p>	<p><i>CIA 4120 (EPDM 10 Shore A)</i></p>	<p><i>CIA 4115 (SBR 10 Shore A)</i></p>

PERFIL ESPONJOSO

<p>CIA 16642 (EPDM 10 Shore A)</p>	<p>CIA 4319 (SBR 15 Shore A)</p>	<p>CIA 4212 (EPDM 15 Shore A)</p>	<p>CIA 4061 (SBR 15 Shore A)</p>
<p>CIA 4114 (SBR 15 Shore A)</p>	<p>CIA 4091 (SBR 10 Shore A)</p>	<p>CIA 4165 (EPDM 15 Shore A)</p>	<p>CIA 4060 (SBR 10 Shore A)</p>
<p>CIA 18314 (SBR 10 Shore A)</p>	<p>CIA 4366 (SBR 10 Shore A)</p>	<p>CIA 4348 (SBR 10 Shore A)</p>	<p>CIA 14121 (EPDM 15 Shore A)</p>
<p>CIA 19224 (EPDM 15 Shore A)</p>	<p>CIA 16601 (EPDM 20 Shore A)</p>	<p>CIA 4093 (SBR 15 Shore A)</p>	<p>CIA 4269 (EPDM 15 Shore A)</p>

PERFIL ESPONJOSO

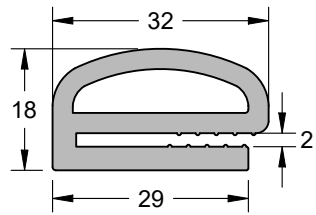
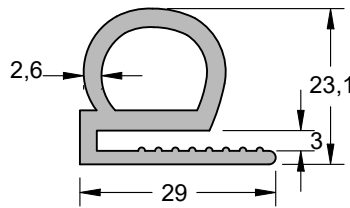
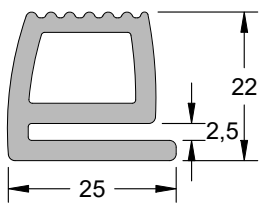
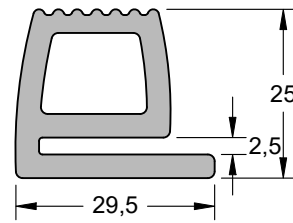
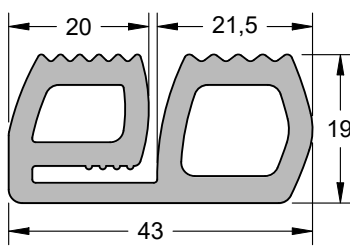
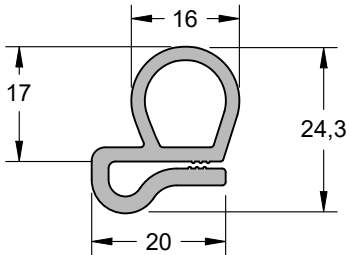
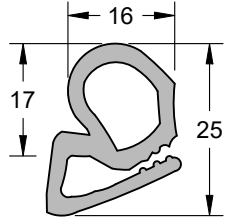
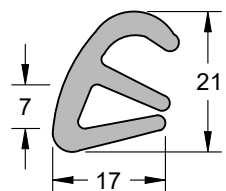
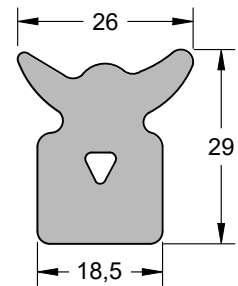
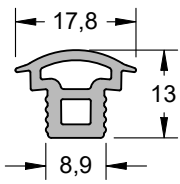
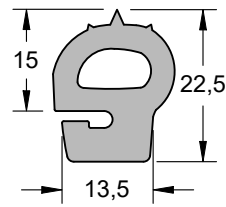
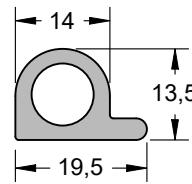
<p><i>CIA 17090 (EPDM 15 Shore A)</i></p> 	<p><i>CIA 4336 (EPDM 15 Shore A - Bege)</i> <i>CIA 17406 (EPDM 15 Shore A)</i></p> 	<p><i>CIA 18956 (SBR 15 Shore A)</i></p> 	<p><i>CIA 4066 (EPDM 15 Shore A)</i></p> 
<p><i>CIA 4059 (SBR 15 Shore A)</i></p> 	<p><i>CIA 4058 (EPDM 15 Shore A)</i></p> 	<p><i>CIA 4391 (EPDM 15 Shore A)</i></p> 	<p><i>CIA 4396 (EPDM 15 Shore A)</i></p> 
<p><i>CIA 4112 (EPDM 10 Shore A)</i></p> 	<p><i>CIA 15710 (EPDM 15 Shore A)</i></p> 	<p><i>CIA 4326 (EPDM 15 Shore A)</i></p> 	<p><i>CIA 4172 (SBR 15 Shore A)</i></p> 

PERFIL ESPONJOSO

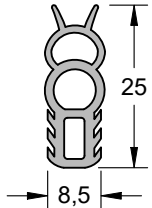
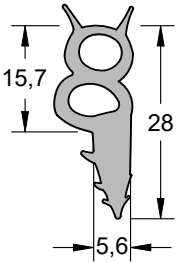
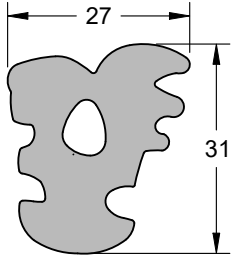
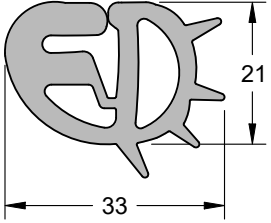
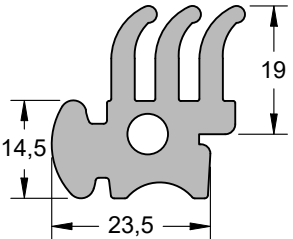
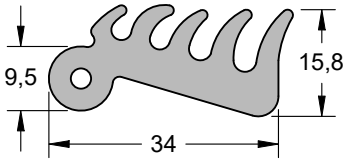
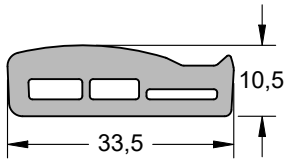
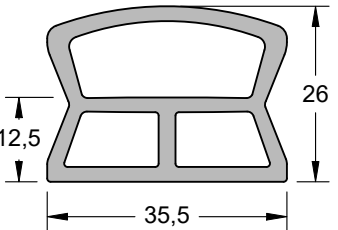
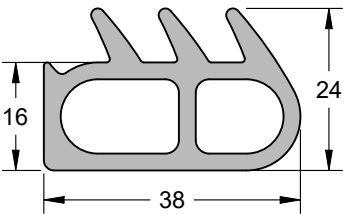
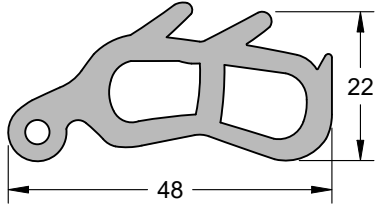
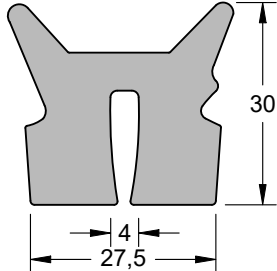
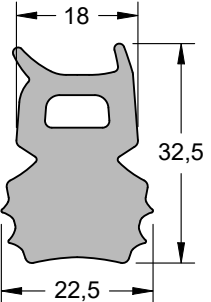
<p><i>CIA 16604 (EPDM 30 Shore A)</i></p> 	<p><i>CIA 15457 (EPDM 30 Shore A)</i></p> 	<p><i>CIA 4173 (EPDM 10 Shore A)</i></p> 	<p><i>CIA 4355 (SBR 30 Shore A)</i></p> 
<p><i>CIA 4375 (EPDM 15 Shore A)</i></p> 	<p><i>CIA 4380 (EPDM 30 Shore A)</i></p> 	<p><i>CIA 4372 (EPDM 30 Shore A)</i></p> 	<p><i>CIA 4360 (EPDM 15 Shore A)</i></p> 
<p><i>CIA 4369 (EPDM 30 Shore A)</i></p> 	<p><i>CIA 4368 (EPDM 30 Shore A)</i></p> 	<p><i>CIA 4133 (SBR 15 Shore A)</i></p> 	<p><i>CIA 4301 (EPDM 10 Shore A)</i></p> 

PERFIL ESPONJOSO

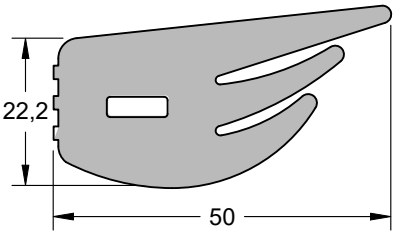
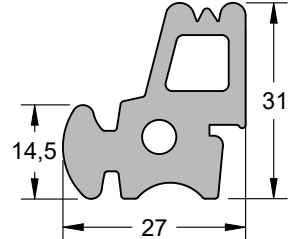
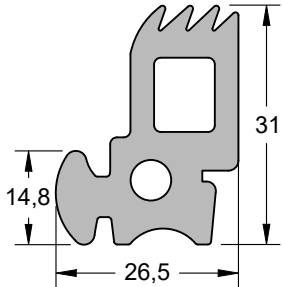
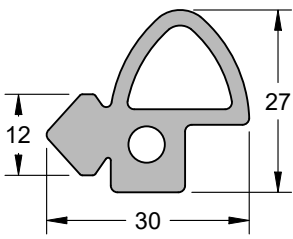
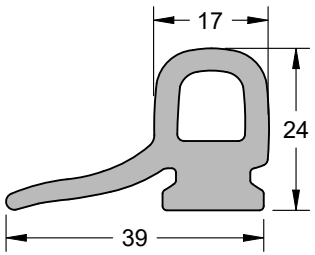
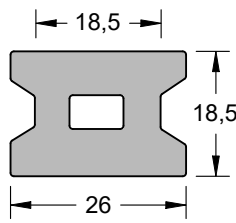
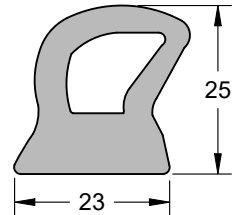
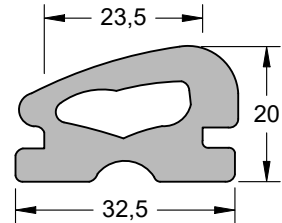
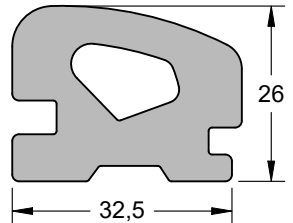
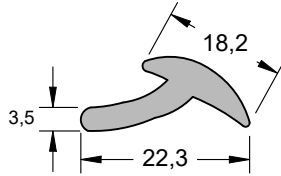
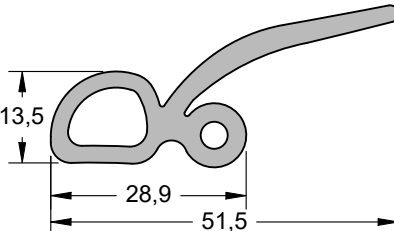
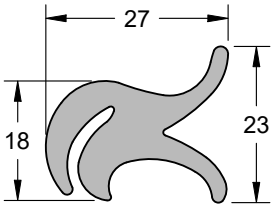
<p><i>CIA 4379 (EPDM 15 Shore A)</i></p> 	<p><i>CIA 4313 (EPDM 15 Shore A)</i></p> 	<p><i>CIA 4309 (EPDM 15 Shore A)</i></p> 	<p><i>CIA 4270 (EPDM 15 Shore A)</i></p> 
<p><i>CIA 4190 (EPDM 10 Shore A)</i></p> 	<p><i>CIA 14534 (SBR 10 Shore A)</i></p> 	<p><i>CIA 4123 (EPDM 15 Shore A)</i></p> 	<p><i>CIA 14537 (SBR 10 Shore A)</i></p> 
<p><i>CIA 4092 (SBR 10 Shore A)</i></p> 	<p><i>CIA 14229 (EPDM 15 Shore A)</i></p> 	<p><i>CIA 4365 (EPDM 30 Shore A)</i></p> 	<p><i>CIA 4305 (SBR 30 Shore A)</i></p> 

PERFIL ESPONJOSO

<p><i>CIA 4367 (EPDM 15 Shore A)</i></p>	<p><i>CIA 4318 (EPDM 15 Shore A)</i></p>	<p><i>CIA 4394 (EPDM 15 Shore A)</i></p>
<p><i>CIA 4386 (EPDM 15 Shore A)</i></p>	<p><i>CIA 4174 (EPDM 10 Shore A)</i></p>	<p><i>CIA 16958 (EPDM 15 Shore A)</i></p>
<p><i>CIA 4376 (EPDM 15 Shore A)</i></p>	<p><i>CIA 4304 (EPDM 15 Shore A)</i></p>	<p><i>CIA 4393 (EPDM 15 Shore A)</i></p>

PERFIL ESPONJOSO

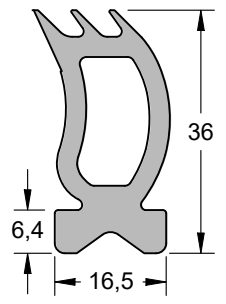
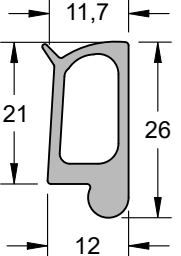
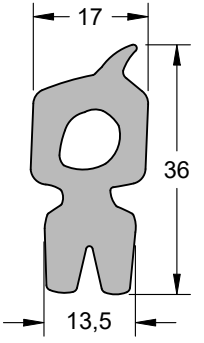
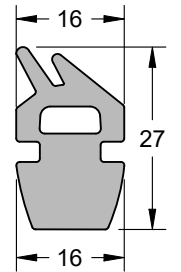
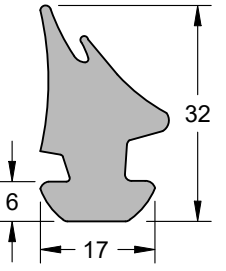
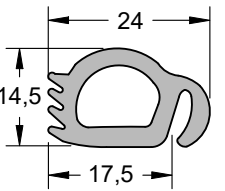
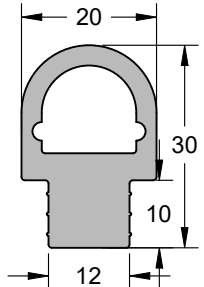
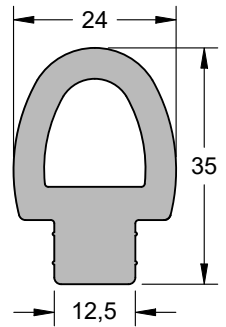
<p><i>CIA 16868 (EPDM 20 Shore A)</i></p> 	<p><i>CIA 4354 (EPDM 25 Shore A)</i></p> 	<p><i>CIA 4223 (EPDM 15 Shore A)</i></p> 	<p><i>CIA 15024 (EPDM 15 Shore A)</i></p> 
<p><i>CIA 4314 (EPDM 10 Shore A)</i></p> 	<p><i>CIA 4057 (EPDM 15 Shore A)</i></p> 	<p><i>CIA 19122 (EPDM 15 Shore A)</i></p> 	<p><i>CIA 4296 (EPDM 15 Shore A)</i></p> 

PERFIL ESPONJOSO

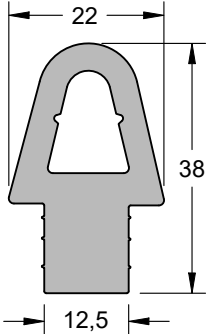
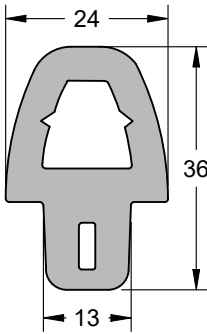
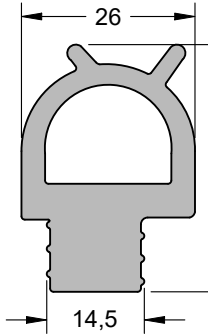
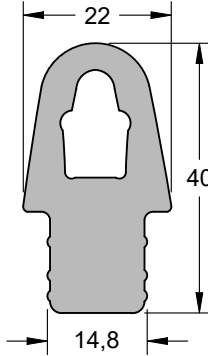
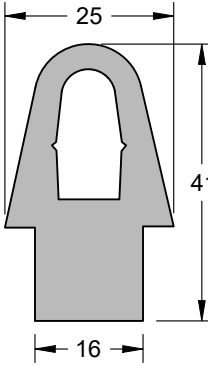
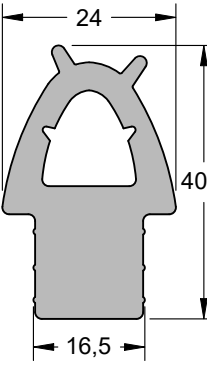
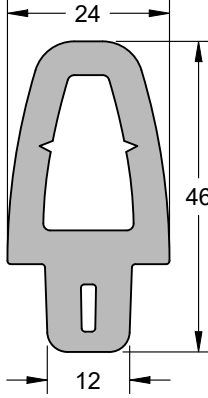
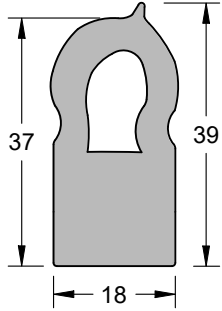
<p><i>CIA 4071 (EPDM 15 Shore A)</i></p> 	<p><i>CIA 4407 (EPDM 15 Shore A)</i></p> 	<p><i>CIA 4256 (EPDM 15 Shore A)</i></p> 	<p><i>CIA 15006 (EPDM 15 Shore A)</i></p> 
<p><i>CIA 4400 (EPDM 15 Shore A)</i></p> 	<p><i>CIA 4217 (EPDM 15 Shore A)</i></p> 	<p><i>CIA 4346 (EPDM 30 Shore A)</i></p> 	<p><i>CIA 4131 (EPDM 10 Shore A)</i></p> 

PERFIL ESPONJOSO

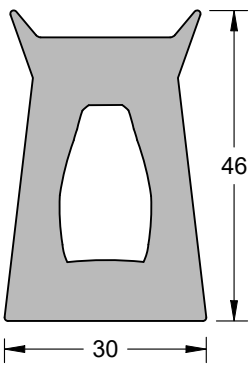
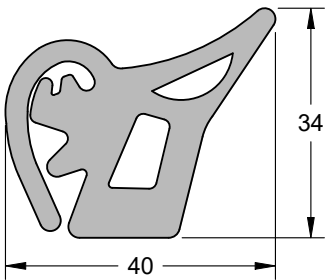
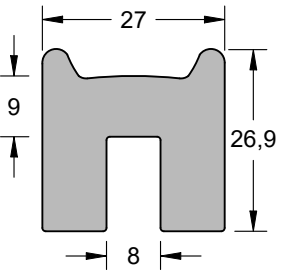
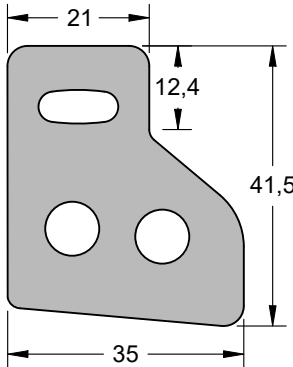
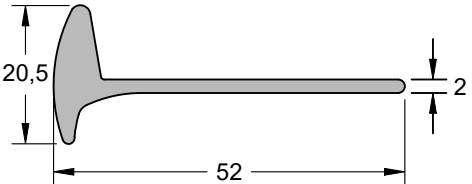
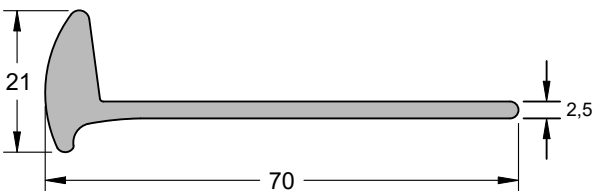
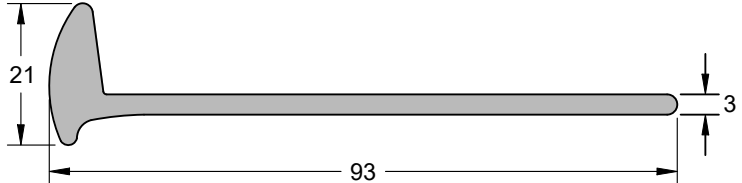
<p><i>CIA 18852 (EPDM 15 Shore A)</i></p> 	<p><i>CIA 18515 (EPDM 10 Shore A)</i></p> 	<p><i>CIA 15020 (SBR 15 Shore A)</i></p> 	<p><i>CIA 18446 (SBR 10 Shore A)</i></p> 
<p><i>CIA 4291 (EPDM 10 Shore A)</i></p> 		<p><i>CIA 4292 (EPDM 10 Shore A)</i></p> 	
<p><i>CIA 4293 (EPDM 10 Shore A)</i></p> 			

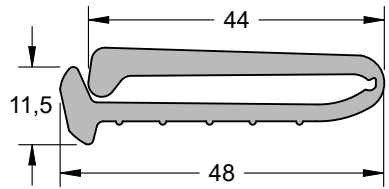
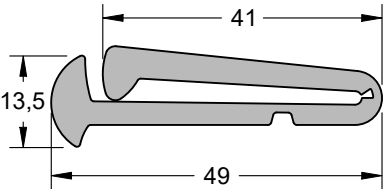
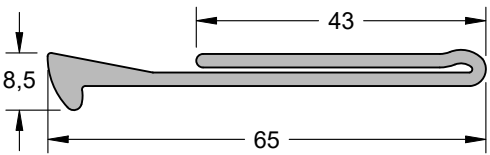
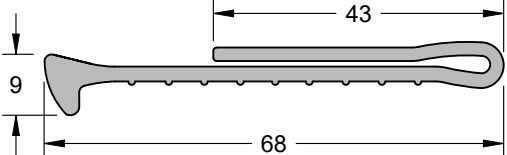
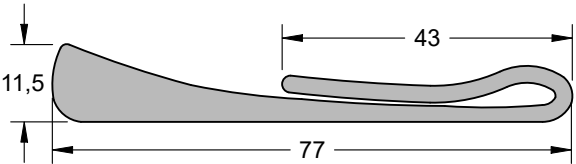
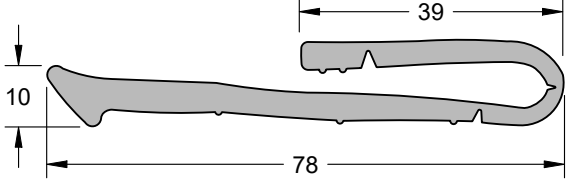
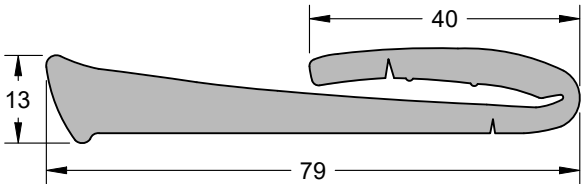
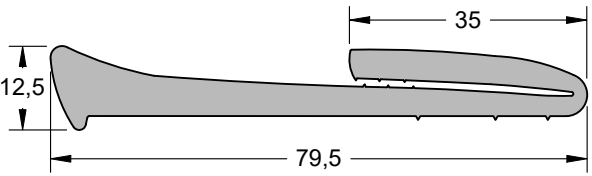
<p><i>CIA 4275 (EPDM 25 Shore A)</i></p> 	<p><i>CIA 4138 (EPDM 25 Shore A)</i></p> 
<p><i>CIA 4177 (EPDM 10 Shore A)</i></p> 	<p><i>CIA 4273 (EPDM 10 Shore A)</i></p> 
<p><i>CIA 4161 (EPDM 10 Shore A)</i></p> 	<p><i>CIA 4088 (EPDM 25 Shore A)</i></p> 
<p><i>CIA 4090 (EPDM 25 Shore A)</i></p> 	<p><i>CIA 4085 (EPDM 25 Shore A)</i></p> 

PERFIL ESPONJOSO

CIA 4086 (EPDM 25 Shore A)

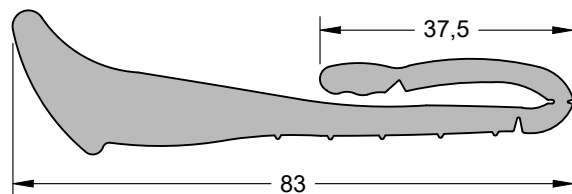

CIA 4294 (EPDM 10 Shore A)

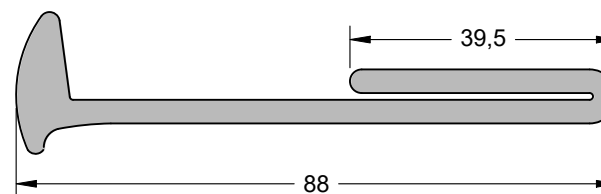

CIA 4166 (EPDM 10 Shore A)

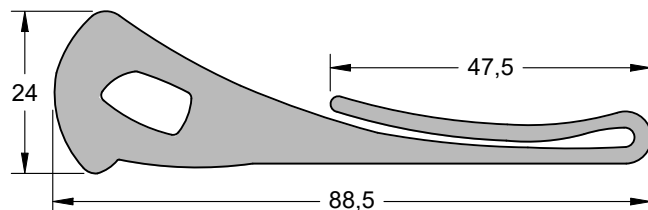

CIA 4272 (EPDM 10 Shore A)

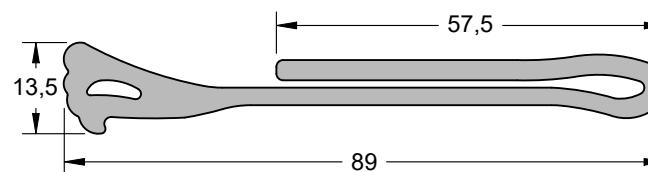

CIA 4178 (EPDM 10 Shore A)

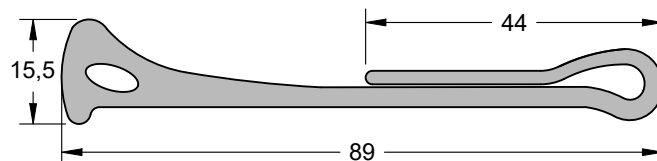

CIA 4274 (EPDM 10 Shore A)

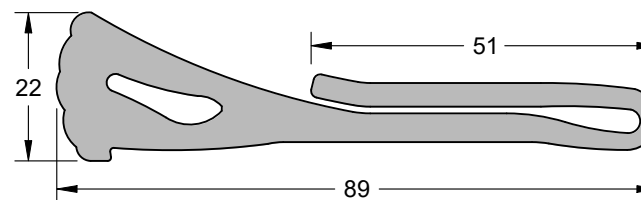

PERFIL ESPONJOSO

CIA 4284 (EPDM 10 Shore A)

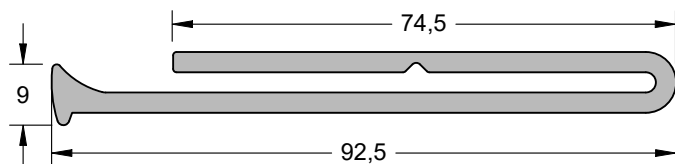

CIA 4148 (EPDM 25 Shore A)

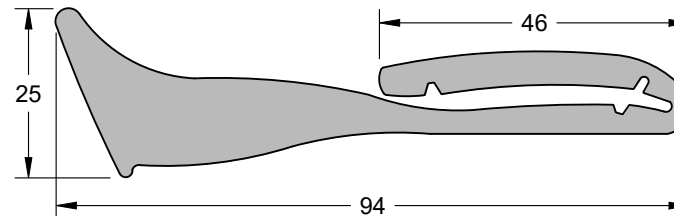

CIA 4283 (EPDM 10 Shore A)

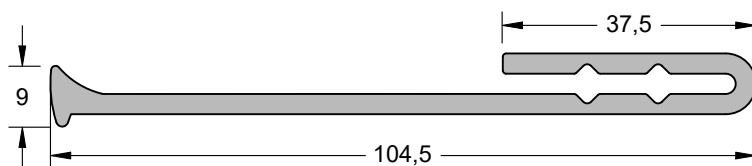



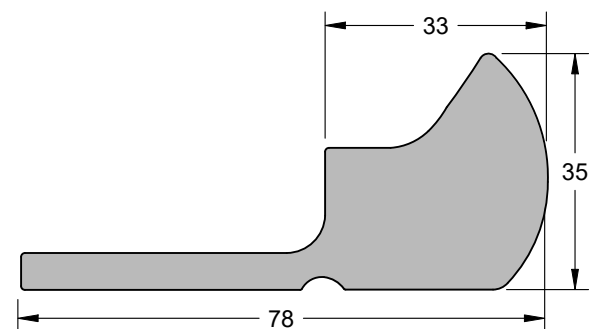



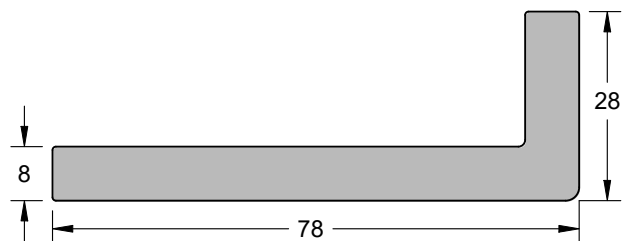



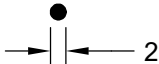



CIA 4160 (SBR 15 Shore A)





CIA 4356 (SBR 15 Shore A)



PERFIL MACIÇO

<p><i>CIA 18252 (NBR 70 Shore A)</i></p> 	<p><i>CIA 18253 (NBR 70 Shore A)</i></p> 	<p><i>CIA 18254 (NBR 70 Shore A)</i> <i>CIA 18255 (EPDM 80 Shore A)</i></p> 	<p><i>CIA 18256 (EPDM 70 Shore A)</i> <i>CIA 18257 (NBR 70 Shore A)</i></p> 
<p><i>CIA 18258 (NBR 70 Shore A)</i> <i>CIA 18259 (EPDM 80 Shore A)</i> <i>CIA 18260 (TPE 60 Shore A)</i></p> 	<p><i>CIA 18261 (NBR 70 Shore A)</i> <i>CIA 18262 (EPDM 80 Shore A)</i></p> 	<p><i>CIA 18264 (NBR 70 Shore A)</i></p> 	<p><i>CIA 18265 (NBR 70 Shore A)</i> <i>CIA 18266 (EPDM 70 Shore A)</i> <i>CIA 18267 (TPE 60 Shore A)</i></p> 
<p><i>CIA 18268 (NBR 70 Shore A)</i></p> 	<p><i>CIA16559 (EPDM 70 Shore A)</i> <i>CIA 18269 (NBR 70 Shore A)</i></p> 	<p><i>CIA 18270 (NBR 70 Shore A)</i></p> 	<p><i>CIA 18271 (NBR 70 Shore A)</i></p> 
<p><i>CIA 18272 (NBR 70 Shore A)</i></p> 	<p><i>CIA 18273 (NBR 70 Shore A)</i></p> 	<p><i>CIA 18274 (NBR 70 Shore A)</i></p> 	<p><i>CIA 18275 (NBR 70 Shore A)</i></p> 

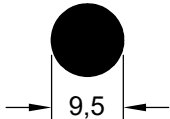
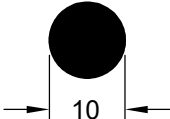
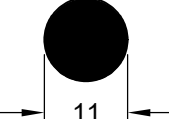
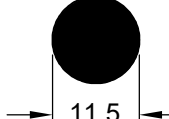
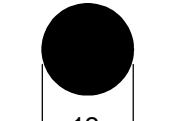
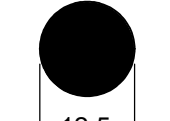
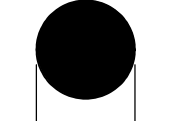
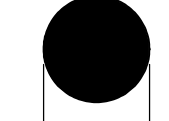
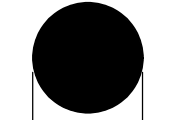
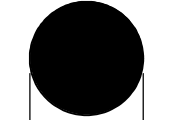
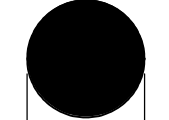
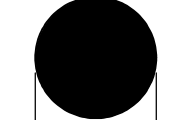
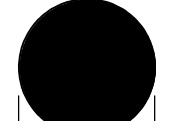
PERFIL MACIÇO

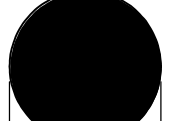
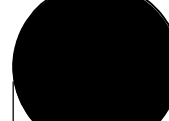
<p><i>CIA 18276 (NBR 70 Shore A)</i></p>  <p>9,5</p>	<p><i>CIA 18240 (EPDM 70 Shore A)</i> <i>CIA 18277 (NBR 70 Shore A)</i></p>  <p>10</p>	<p><i>CIA 18278 (NBR 70 Shore A)</i></p>  <p>11</p>	<p><i>CIA 18279 (NBR 70 Shore A)</i></p>  <p>11,5</p>
<p><i>CIA 18280 (NBR 70 Shore A)</i></p>  <p>12</p>	<p><i>CIA 18281 (NBR 70 Shore A)</i></p>  <p>12,5</p>	<p><i>CIA 18282 (NBR 70 Shore A)</i></p>  <p>13</p>	<p><i>CIA 18283 (NBR 70 Shore A)</i></p>  <p>14</p>
<p><i>CIA 18284 (NBR 70 Shore A)</i></p>  <p>14,5</p>	<p><i>CIA 18285 (NBR 70 Shore A)</i></p>  <p>15</p>	<p><i>CIA 18286 (NBR 70 Shore A)</i></p>  <p>15,5</p>	<p><i>CIA 18287 (NBR 70 Shore A)</i> <i>CIA 18288 (EPDM 70 Shore A)</i></p>  <p>16</p>
<p><i>CIA 18801 (EPDM 70 Shore A)</i></p>  <p>18</p>	<p><i>CIA 18228 (EPDM 70 Shore A)</i> <i>CIA 18289 (NBR 70 Shore A)</i></p>  <p>19</p>	<p><i>CIA 18227 (EPDM 70 Shore A)</i></p>  <p>20</p>	<p><i>CIA 18290 (NBR 70 Shore A)</i> <i>CIA 18291 (NR 50 Shore A)</i></p>  <p>22</p>

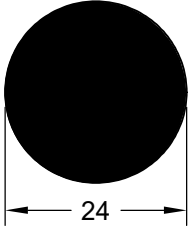
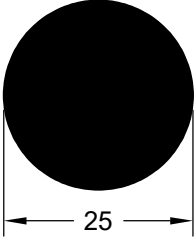
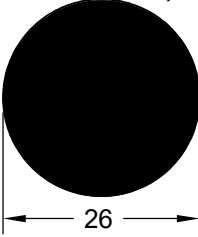
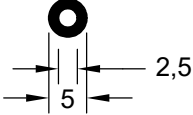
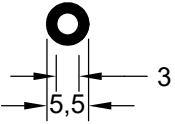
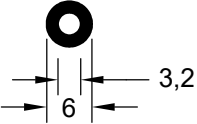
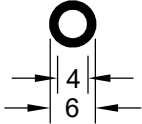
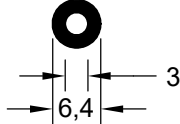
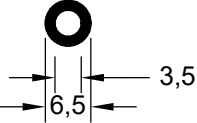
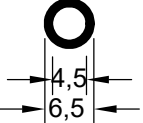
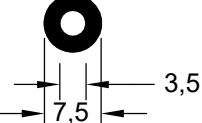
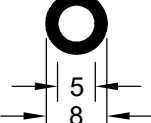
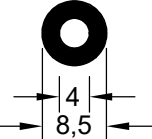
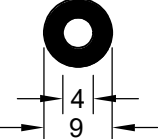
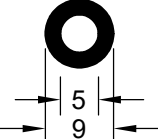
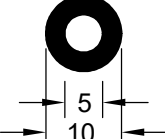
<p>CIA 18292 (NR 50 Shore A) CIA 18293 (NBR 70 Shore A)</p>  <p>24</p>	<p>CIA 18294 (NBR 70 Shore A)</p>  <p>25</p>	<p>CIA 18295 (NR 50 Shore A) CIA 18296 (EPDM 70 Shore A)</p>  <p>26</p>	<p>CIA 6156 (EPDM 70 Shore A) CIA 6350 (NBR 70 Shore A)</p>  <p>2,5 5</p>
<p>CIA 18330 (EPDM 63 Shore A)</p>  <p>3 5,5</p>	<p>CIA 16590 (EPDM 70 Shore A)</p>  <p>3,2 6</p>	<p>CIA 6461 (EPDM 70 Shore A) CIA 16462 (NBR 70 Shore A)</p>  <p>4 6</p>	<p>CIA 6433 (EPDM 70 Shore A)</p>  <p>3 6,4</p>
<p>CIA 16032 (EPDM 63 Shore A)</p>  <p>3,5 6,5</p>	<p>CIA 18804 (EPDM 63 Shore A)</p>  <p>4,5 6,5</p>	<p>CIA 6154 (CR 70 Shore A)</p>  <p>3,5 7,5</p>	<p>CIA 17095 (EPDM 63 Shore A)</p>  <p>5 8</p>
<p>CIA 6056 (EPDM 80 Shore A)</p>  <p>4 8,5</p>	<p>CIA 6047 (NBR 70 Shore A)</p>  <p>4 9</p>	<p>CIA 17703 (EPDM 70 Shore A)</p>  <p>5 9</p>	<p>CIA 17864 (EPDM 70 Shore A)</p>  <p>5 10</p>

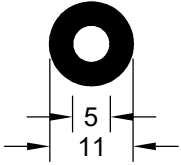
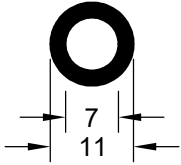
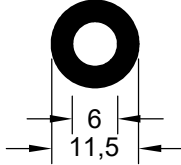
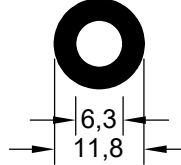
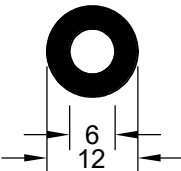
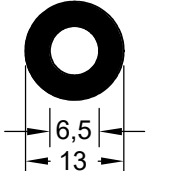
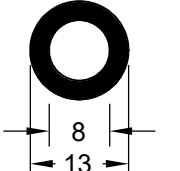
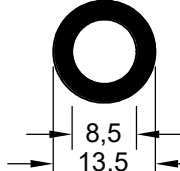
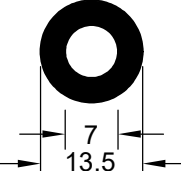
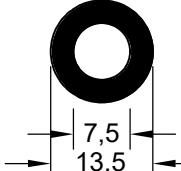
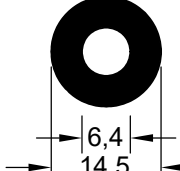
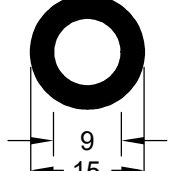
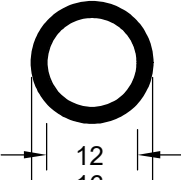
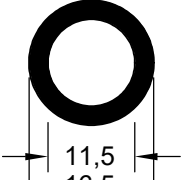
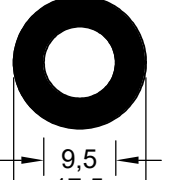
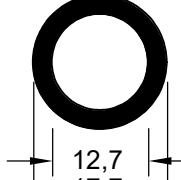
<p><i>CIA 6097 (NBR 70 Shore A)</i></p> 	<p><i>CIA 6062 (NBR 70 Shore A)</i> <i>CIA 16428 (EPDM 70 Shore A)</i></p> 	<p><i>CIA 6358 (EPDM 80 Shore A)</i></p> 	<p><i>CIA 6018 (EPDM 63 Shore A)</i></p> 
<p><i>CIA 6187 (EPDM 63 Shore A)</i></p> 	<p><i>CIA 6022 (EPDM 60 Shore A)</i></p> 	<p><i>CIA 18584 (EPDM 80 Shore A)</i></p> 	<p><i>CIA 17866 (EPDM 55 Shore A)</i></p> 
<p><i>CIA 6356 (EPDM 63 Shore A)</i></p> 	<p><i>CIA 6201 (EPDM 80 Shore A)</i> <i>CIA 16463 (NBR 70 Shore A)</i></p> 	<p><i>CIA 6019 (EPDM 63 Shore A)</i></p> 	<p><i>CIA 6109 (NBR 70 Shore A)</i></p> 
<p><i>CIA 6321 (EPDM 63 Shore A)</i></p> 	<p><i>CIA 17865 (EPDM 55 Shore A)</i></p> 	<p><i>CIA 6269 (EPDM 80 Shore A)</i></p> 	<p><i>CIA 17849 (EPDM 63 Shore A)</i></p> 

PERFIL MACIÇO

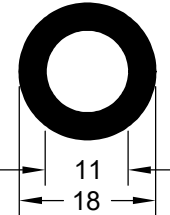
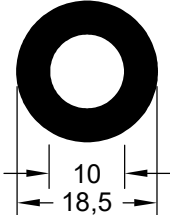
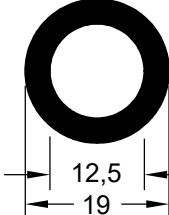
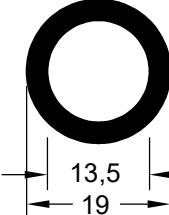
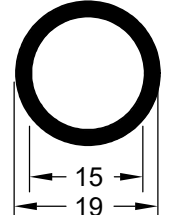
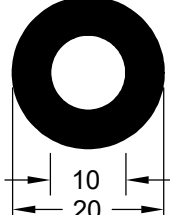
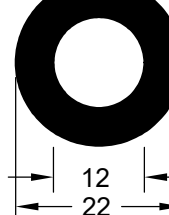
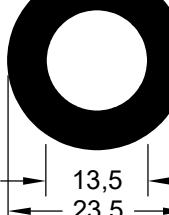
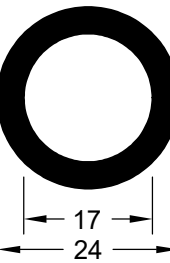
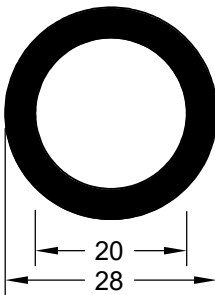
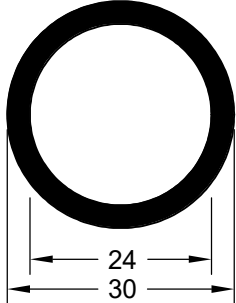
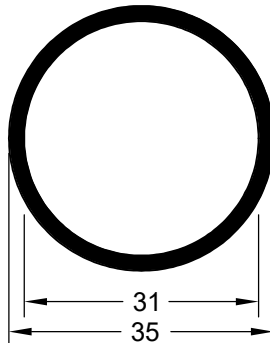
<p><i>CIA 16529 (EPDM 70 Shore A)</i></p> 	<p><i>CIA 16668 (EPDM 70 Shore A)</i></p> 	<p><i>CIA 6065 (EPDM 63 Shore A)</i></p> 	<p><i>CIA 16628 (EPDM 70 Shore A)</i></p> 
<p><i>CIA 17806 (EPDM 63 Shore A)</i></p> 	<p><i>CIA 14555 (NBR 70 Shore A)</i></p> 	<p><i>CIA 6388 (SBR 60 Shore A)</i></p> 	<p><i>CIA 6021 (EPDM 63 Shore A)</i></p> 
<p><i>CIA 7055 (TPE 60 Shore A)</i></p> 	<p><i>CIA 6202 (EPDM 80 Shore A)</i></p> 	<p><i>CIA 16198 (TPV 70 Shore A)</i></p> 	<p><i>CIA 16249 (TPV 70 Shore A)</i></p> 

PERFIL MACIÇO

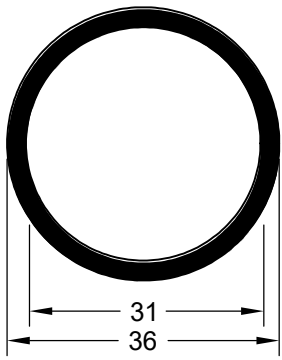
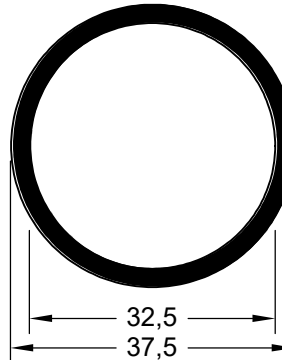
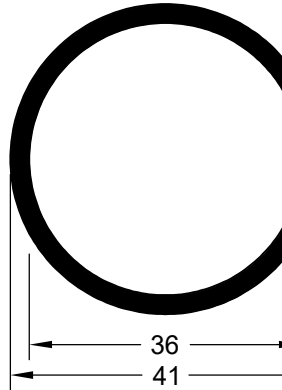
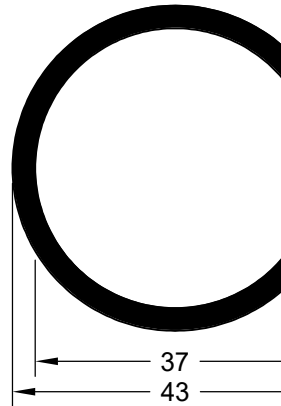
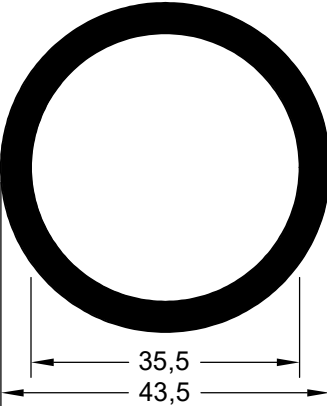
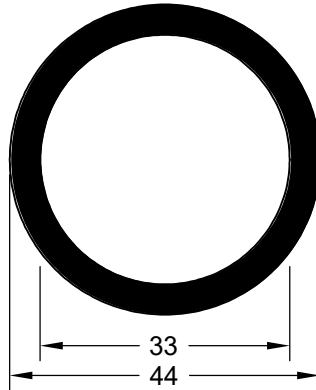
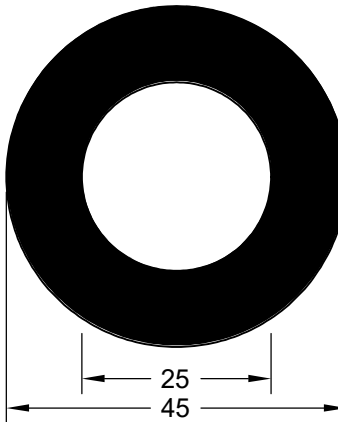
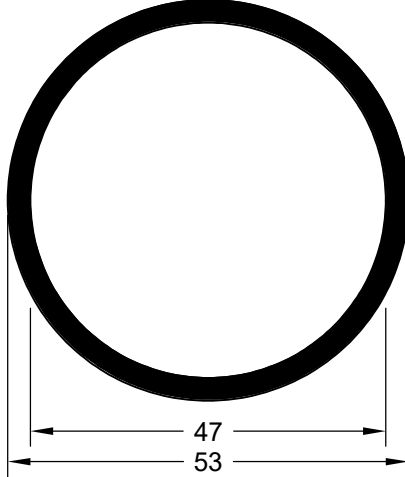
<p><i>CIA 18130 (EPDM 80 Shore A)</i></p>  <p>31 36</p>	<p><i>CIA 6119 (EPDM 70 Shore A)</i></p>  <p>32,5 37,5</p>	<p><i>CIA 17608 (TPE 70 Shore A)</i></p>  <p>36 41</p>	<p><i>CIA 17766 (EPDM 70 Shore A)</i></p>  <p>37 43</p>
<p><i>CIA 18132 (TPE 70 Shore A)</i></p>  <p>35,5 43,5</p>	<p><i>CIA 18734 (TPE 70 Shore A)</i></p>  <p>33 44</p>	<p><i>CIA 14554 (NBR 70 Shore A)</i></p>  <p>25 45</p>	<p><i>CIA 17450 (TPE 70 Shore A)</i></p>  <p>47 53</p>

CIA 16329 (TPE 60 Shore A)

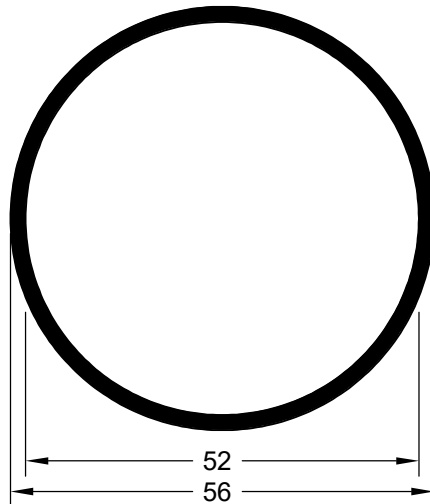

CIA 17515 (TPE 70 Shore A)

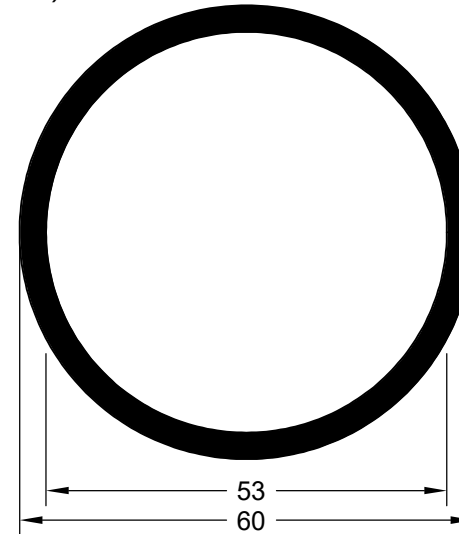

CIA 17455 (TPE 70 Shore A)

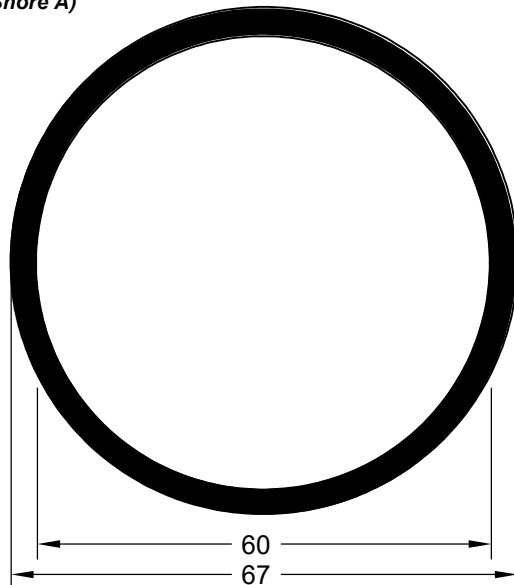

CIA 18425 (TPE 70 Shore A)

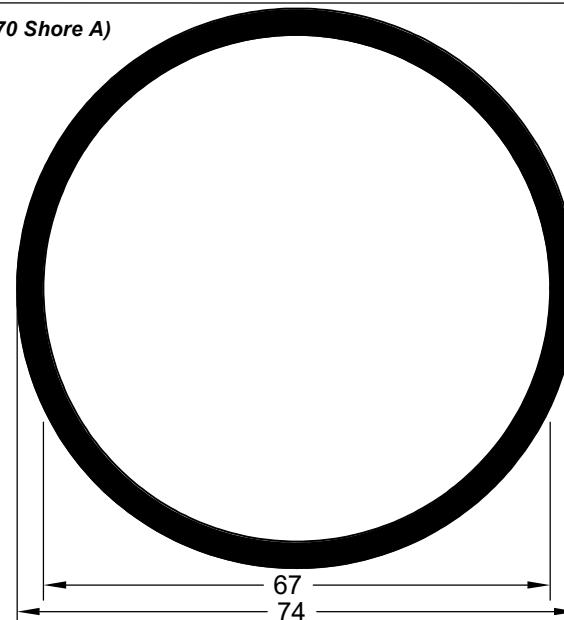

CIA 17561 (TPE 70 Shore A)

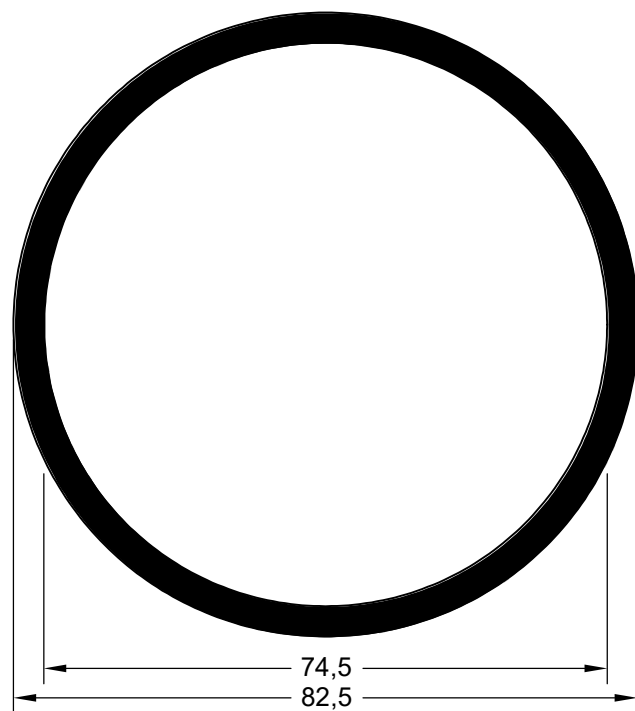

CIA 18661 (TPE 70 Shore A)

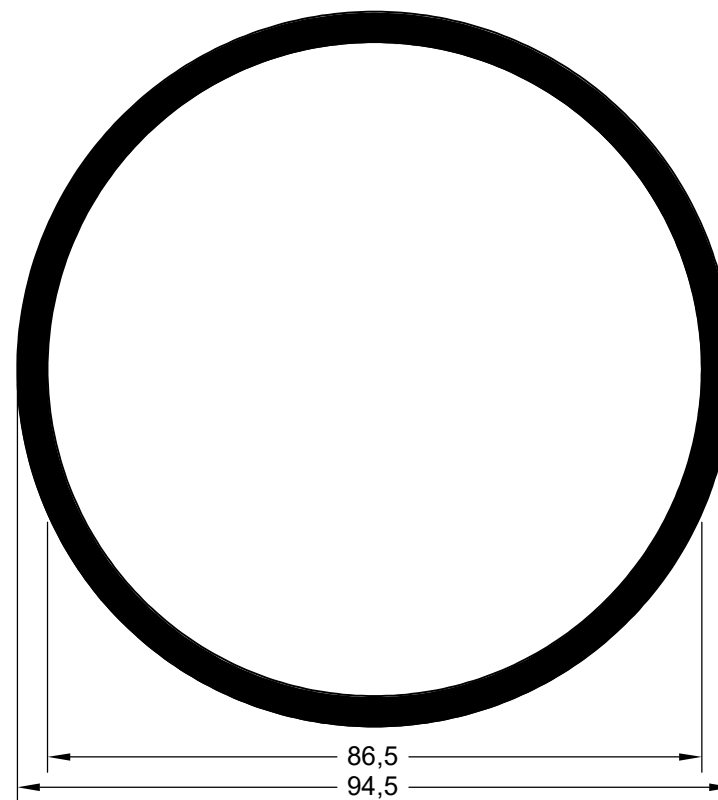

PERFIL MACIÇO

CIA 18144 (TPE 70 Shore A)

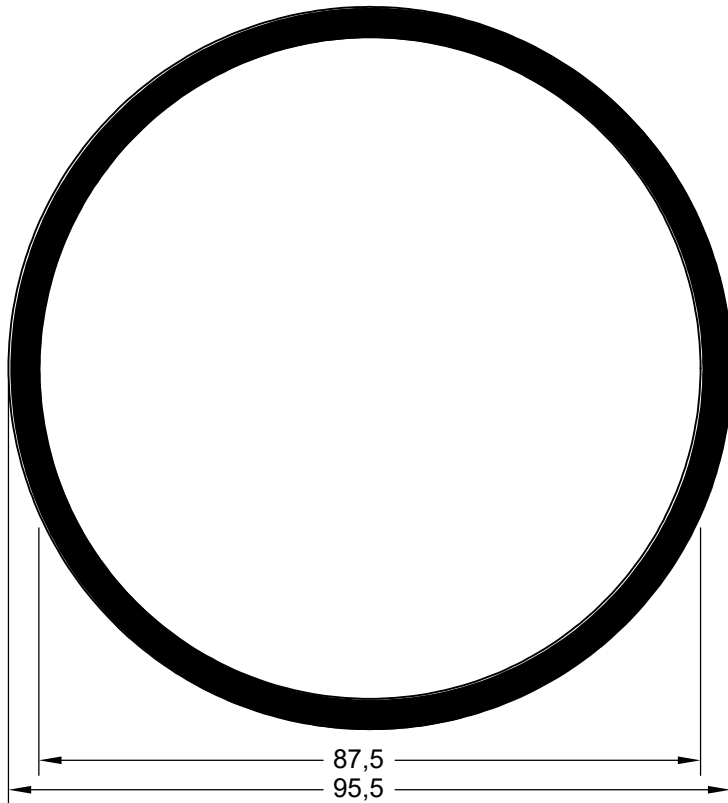

CIA 18595 (EPDM 63 Shore A)

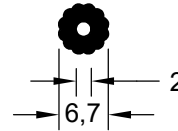

CIA 9162 (EPDM 70 Shore A)

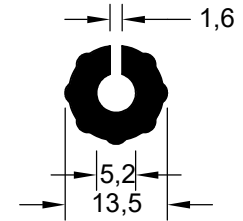

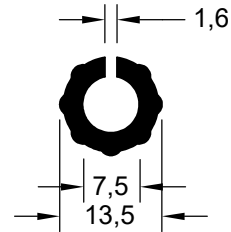

CIA 14383 (EPDM 70 Shore A)



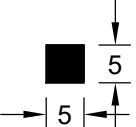
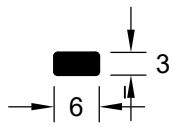
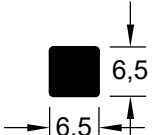
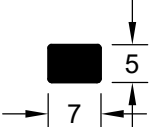
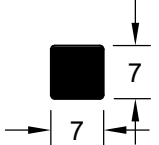
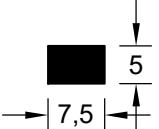
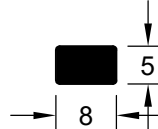
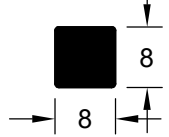
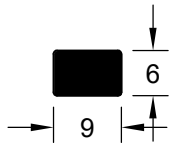
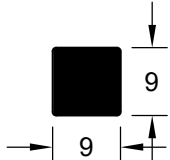
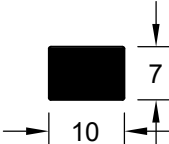
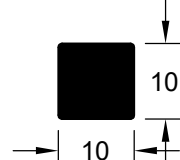
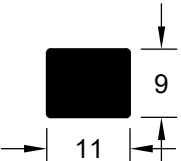
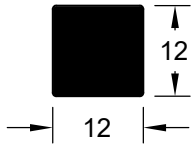
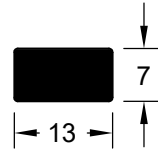
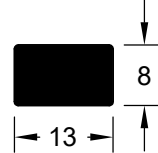

PERFIL MACIÇO

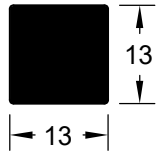
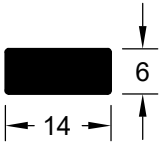
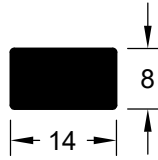
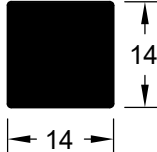
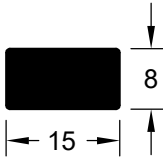
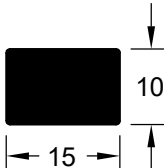
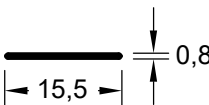
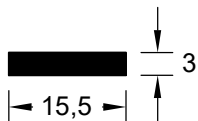
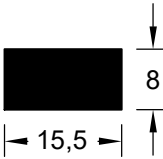
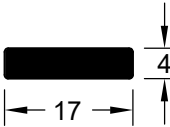
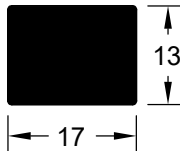
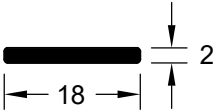
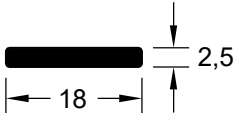
<p><i>CIA 16750 (EPDM 63 Shore A)</i></p> 	<p><i>CIA 6479 (EPDM 63 Shore A)</i></p> 	<p><i>CIA 6324 (NBR 70 Shore A)</i></p> 	<p><i>CIA 6495 (EPDM 63 Shore A)</i></p> 
<p><i>CIA 6471 (EPDM 63 Shore A)</i> <i>CIA 16751 (EPDM 70 Shore A)</i></p> 	<p><i>CIA 17644 (EPDM 63 Shore A)</i></p> 	<p><i>CIA 6311 (NBR 70 Shore A)</i></p> 	<p><i>CIA 6083 (NBR 70 Shore A)</i> <i>CIA 14037 (EPDM 70 Shore A)</i> <i>CIA 17560 (NBR 80 Shore A)</i></p> 
<p><i>CIA 6458 (EPDM 70 Shore A)</i></p> 	<p><i>CIA 6086 (NBR 70 Shore A)</i></p> 	<p><i>CIA 16770 (EPDM 70 Shore A)</i></p> 	<p><i>CIA 18562 (EPDM 55 Shore A)</i></p> 
<p><i>CIA 6425 (NBR 70 Shore A)</i></p> 	<p><i>CIA 6053 (NBR 70 Shore A)</i></p> 	<p><i>CIA 6071 (NBR 70 Shore A)</i></p> 	<p><i>CIA 6135 (NBR 70 Shore A)</i></p> 

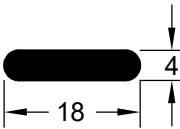
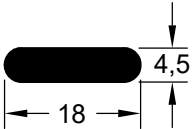
PERFIL MACIÇO

<p><i>CIA 6070 (NBR 70 Shore A)</i></p> 	<p><i>CIA 6136 (NBR 70 Shore A)</i></p> 	<p><i>CIA 6107 (NBR 70 Shore A)</i></p> 	<p><i>CIA 6361 (EPDM 80 Shore A)</i></p> 
<p><i>CIA 6474 (EPDM 80 Shore A)</i></p> 	<p><i>CIA 6473 (EPDM 80 Shore A)</i></p> 	<p><i>CIA 6486 (EPDM 63 Shore A)</i></p> 	<p><i>CIA 16010 (EPDM 70 Shore A)</i></p> 
<p><i>CIA 16011 (EPDM 70 Shore A)</i></p> 	<p><i>CIA 6449 (EPDM 70 Shore A)</i></p> 	<p><i>CIA 6325 (EPDM 70 Shore A)</i></p> 	<p><i>CIA 6260 (NBR 70 Shore A)</i></p> 
<p><i>CIA 6274 (NBR 70 Shore A)</i></p> 	<p><i>CIA 18109 (EPDM 80 Shore A)</i></p> 	<p><i>CIA 6259 (NBR 70 Shore A)</i></p> 	<p><i>CIA 6297 (NBR 70 Shore A)</i></p> 

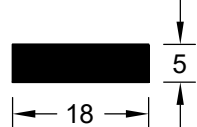
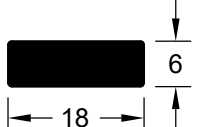
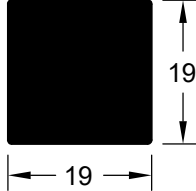
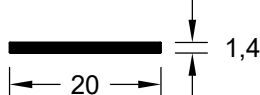
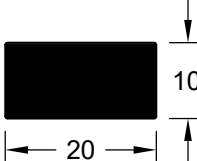

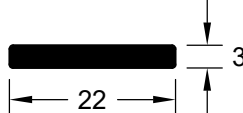
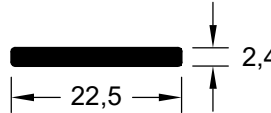
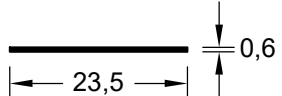
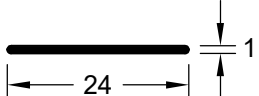
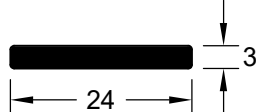
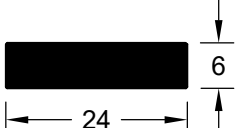
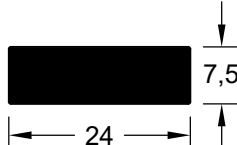
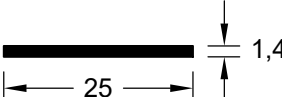
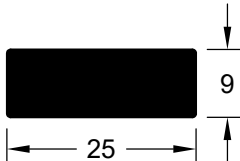
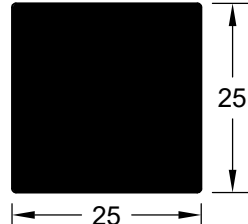

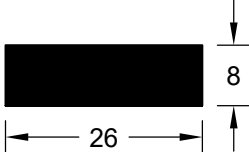
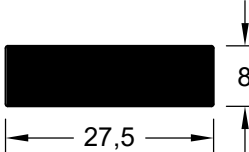
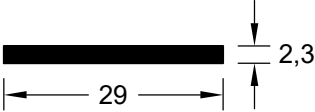
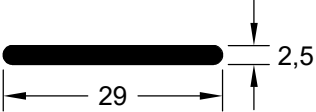
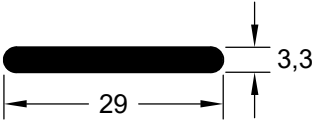
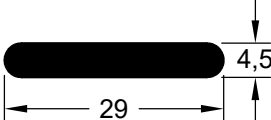
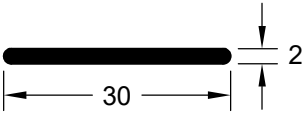
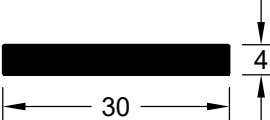
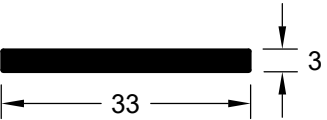
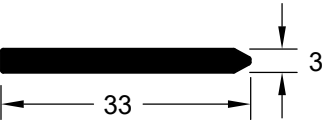
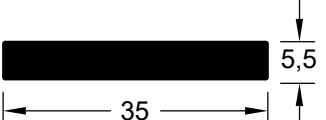
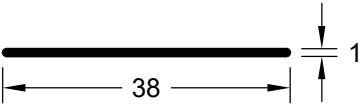
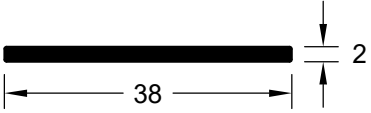
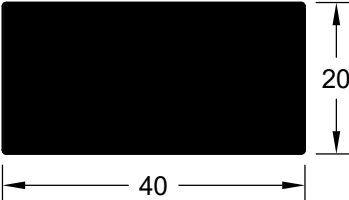
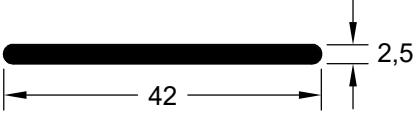
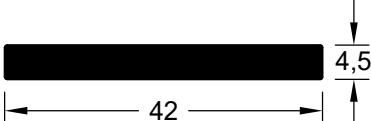

PERFIL MACIÇO

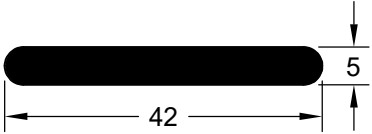
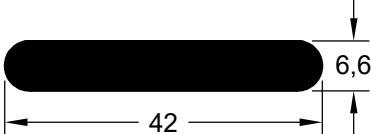
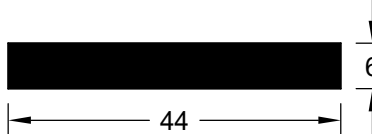

<p><i>CIA 19326 (EPDM 70 Shore A)</i></p> 	<p><i>CIA 6159 (NBR 70 Shore A)</i></p> 	<p><i>CIA 6379 (EPDM 70 Shore A)</i></p> 	<p><i>CIA 17433 (EPDM 70 Shore A)</i></p> 
<p><i>CIA 14360 (EPDM 70 Shore A)</i></p> 	<p><i>CIA 6229 (EPDM 70 Shore A)</i></p> 	<p><i>CIA 6466 (EPDM 70 Shore A)</i></p> 	<p><i>CIA 6464 (EPDM 63 Shore A)</i></p> 
<p><i>CIA 18182 (TPE 70 Shore A)</i></p> 	<p><i>CIA 6193 (EPDM 63 Shore A)</i></p> 	<p><i>CIA 6477 (EPDM 63 Shore A)</i></p> 	<p><i>CIA 19718 (EPDM 80 Shore A)</i></p> 
<p><i>CIA 18728 (EPDM 70 Shore A)</i></p> 	<p><i>CIA 18768 (EPDM 70 Shore A)</i></p> 	<p><i>CIA 6023 (EPDM 70 Shore A)</i></p> 	<p><i>CIA 6395 (NBR 70 Shore A)</i> <i>CIA 16118 (EPDM 70 Shore A)</i></p> 

PERFIL MACIÇO

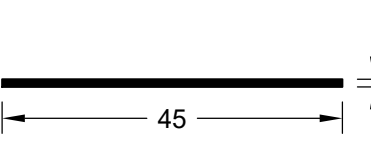
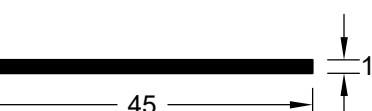
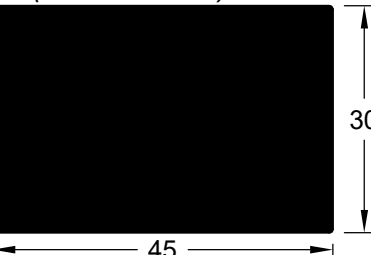
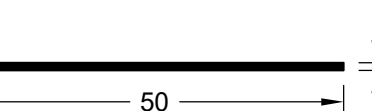
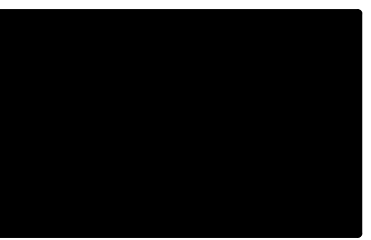
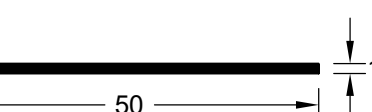
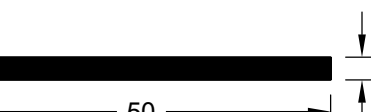
<p><i>CIA 16012 (EPDM 70 Shore A)</i></p> 	<p><i>CIA 6205 (NBR 70 Shore A)</i></p> 	<p><i>CIA 6218 (EPDM 70 Shore A)</i></p> 	<p><i>CIA 6263 (NBR 70 Shore A)</i></p> 
<p><i>CIA 6275 (NBR 70 Shore A)</i></p> 	<p><i>CIA 6262 (NBR 70 Shore A)</i></p> 	<p><i>CIA 7064 (TPE 70 Shore A)</i></p> 	<p><i>CIA 6186 (EPDM 70 Shore A)</i></p> 
<p><i>CIA 6199 (EPDM 70 Shore A)</i></p> 	<p><i>CIA 6105 (SBR 70 Shore A)</i></p> 	<p><i>CIA 6145 (EPDM 70 Shore A)</i></p> 	<p><i>CIA 6310 (EPDM 70 Shore A)</i></p> 
<p><i>CIA 6191 (EPDM 70 Shore A)</i> <i>CIA 16211 (TPE 90 Shore A)</i></p> 	<p><i>CIA 6450 (EPDM 63 Shore A)</i></p> 	<p><i>CIA 6276 (NBR 70 Shore A)</i></p> 	<p><i>CIA 6231 (NBR 70 Shore A)</i></p> 

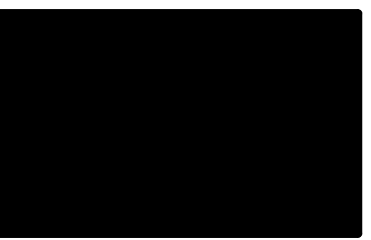

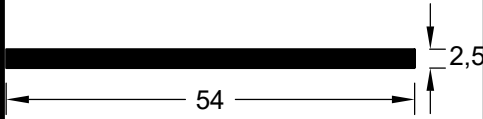
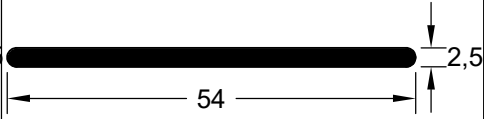
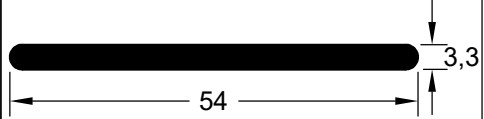
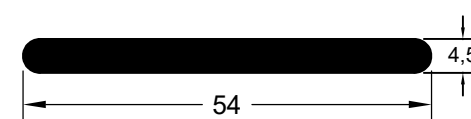
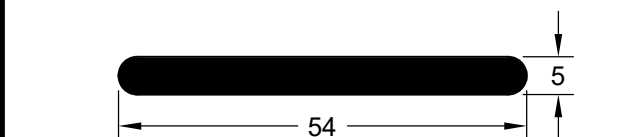
PERFIL MACIÇO

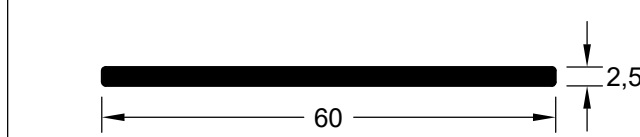
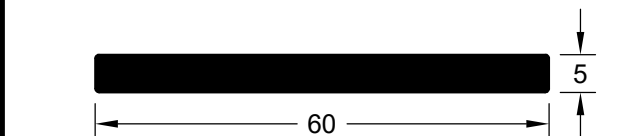
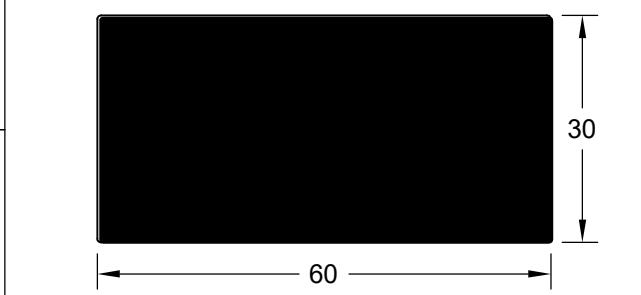
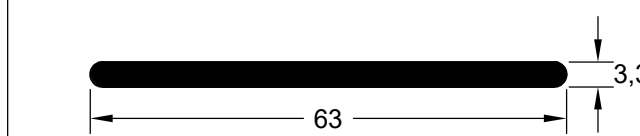
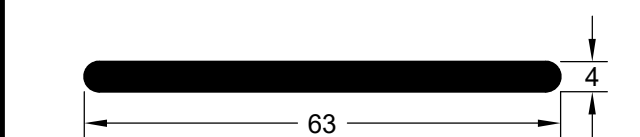
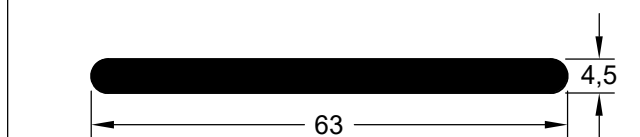

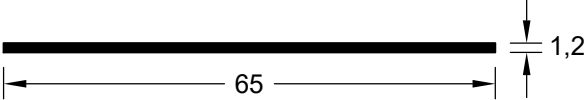
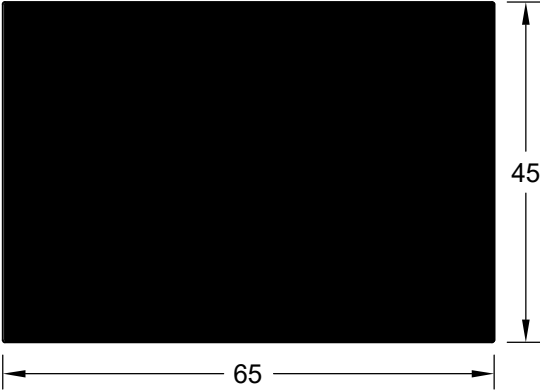
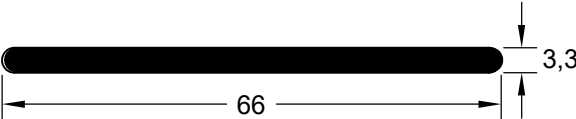
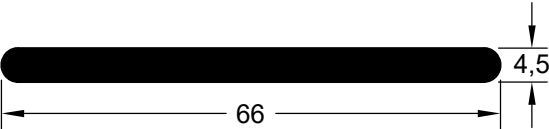
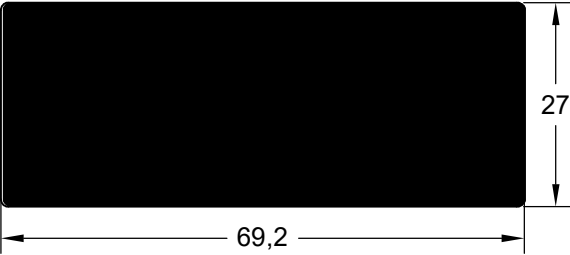
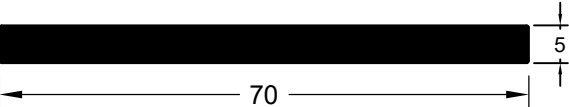
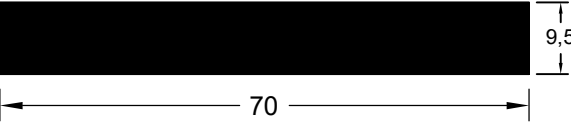
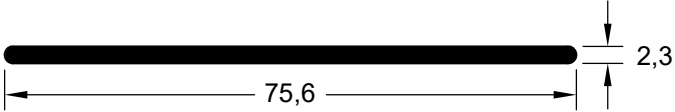
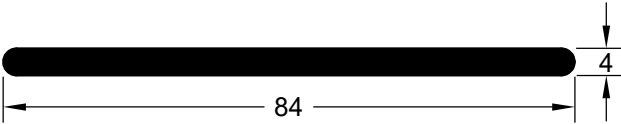

<p><i>CIA 6298 (NBR 70 Shore A)</i></p> 	<p><i>CIA 6257 (NBR 70 Shore A)</i></p> 	<p><i>CIA 17790 (EPDM 70 Shore A)</i></p> 	<p><i>CIA 14205 (EPDM 70 Shore A)</i></p> 
<p><i>CIA 17667 (EPDM 70 Shore A)</i></p> 	<p><i>CIA 6409 (EPDM 80 Shore A)</i></p> 	<p><i>CIA 17389 (EPDM 80 Shore A)</i></p> 	<p><i>CIA 6344 (EPDM 63 Shore A)</i></p> 
<p><i>CIA 18189 (NBR 60 Shore A)</i></p> 	<p><i>CIA 6137 (EPDM 70 Shore A)</i></p> 	<p><i>CIA 6024 (EPDM 70 Shore A)</i></p> 	<p><i>CIA 6115 (EPDM 70 Shore A)</i></p> 
<p><i>CIA 18987 (EPDM 70 Shore A)</i></p> 	<p><i>CIA 6442 (EPDM 70 Shore A)</i> <i>CIA 6453 (NBR 70 Shore A)</i></p> 	<p><i>CIA 6200 (EPDM 70 Shore A)</i></p> 	<p><i>CIA 6115 (EPDM 70 Shore A)</i></p> 

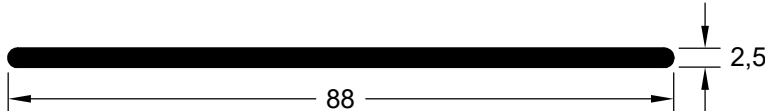
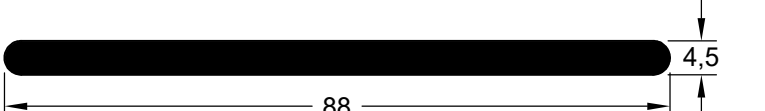
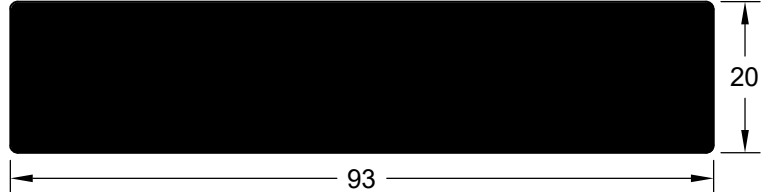
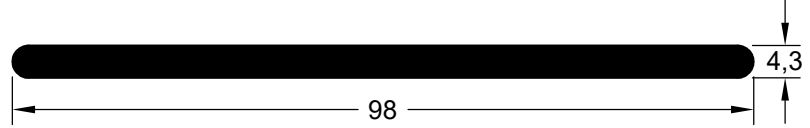
<p><i>CIA 17631 (EPDM 70 Shore A)</i></p> 	<p><i>CIA 6277 (NBR 70 Shore A)</i></p> 	<p><i>CIA 6264 (NBR 70 Shore A)</i></p> 	<p><i>CIA 6281 (NBR 70 Shore A)</i></p> 
<p><i>CIA 6299 (EPDM 70 Shore A)</i></p> 	<p><i>CIA 6261 (EPDM 70 Shore A)</i></p> 	<p><i>CIA 6271 (EPDM 70 Shore A)</i></p> 	
<p><i>CIA 19717 (EPDM 70 Shore A)</i></p> 	<p><i>CIA 6114 (EPDM 70 Shore A)</i></p> 	<p><i>CIA 6253 (NBR 70 Shore A)</i></p> 	
<p><i>CIA 6252 (NBR 70 Shore A)</i></p> 			<p><i>CIA 6251 (NBR 70 Shore A)</i></p> 

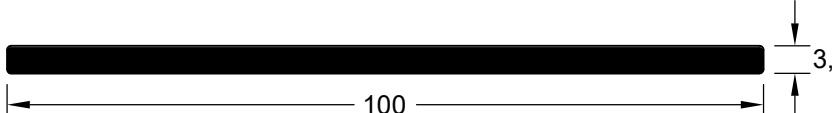
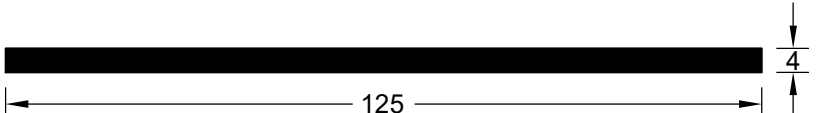
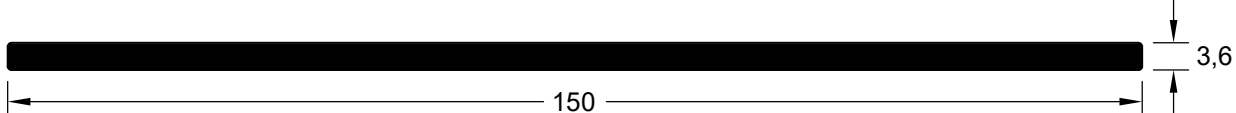
PERFIL MACIÇO

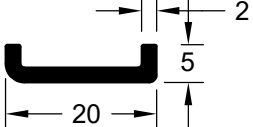
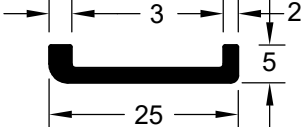
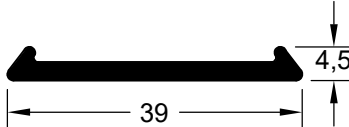
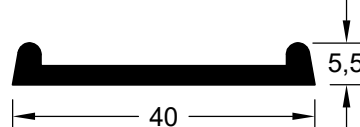
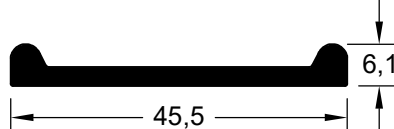
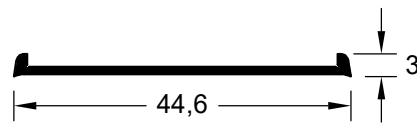
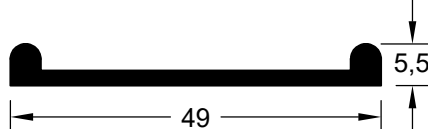
<p><i>CIA 17340 (EPDM 70 Shore A)</i></p> 	<p><i>CIA 6209 (EPDM 70 Shore A)</i></p> 	<p><i>CIA 6282 (NBR 70 Shore A)</i></p> 
<p><i>CIA 6283 (NBR 70 Shore A)</i></p> 	<p><i>CIA 17325 (EPDM 80 Shore A)</i></p> 	
<p><i>CIA 6144 (EPDM 70 Shore A)</i></p> 	<p><i>CIA 17842 (EPDM 70 Shore A)</i></p> 	
<p><i>CIA 6248 (NBR 70 Shore A)</i></p> 	<p><i>CIA 6249 (NBR 70 Shore A)</i></p> 	

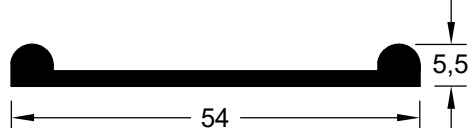
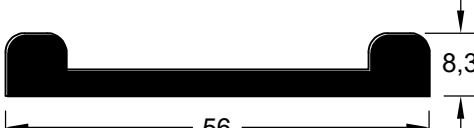
<p><i>CIA 6278 (NBR 70 Shore A)</i></p> 	<p><i>CIA 6279 (NBR 70 Shore A)</i></p> 
<p><i>CIA 17850 (EPDM 80 Shore A)</i></p> 	<p><i>CIA 6250 (NBR 70 Shore A)</i></p> 
<p><i>CIA 6270 (EPDM 70 Shore A)</i></p> 	<p><i>CIA 9155 (EPDM 70 Shore A)</i></p> 
<p><i>CIA 6290 (EPDM 70 Shore A)</i></p> 	<p><i>CIA 14619 (TPE 70 Shore A)</i></p> 
<p><i>CIA 7077 (TPE 85 Shore A)</i></p> 	

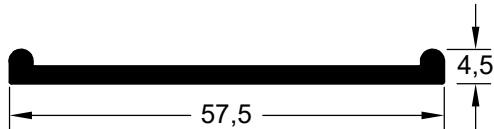
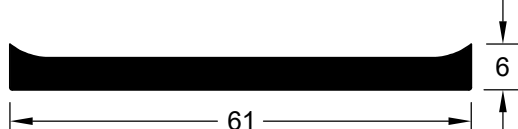
<p><i>CIA 6402 (EPDM 70 Shore A)</i></p> 	<p><i>CIA 6401 (EPDM 70 Shore A)</i></p> 	<p><i>CIA 6082 (EPDM 70 Shore A)</i></p> 	<p><i>CIA 17171 (TPE 70 Shore A)</i></p> 
<p><i>CIA 16473 (TPE 70 Shore A)</i></p> 	<p><i>CIA 6413 (EPDM 70 Shore A)</i></p> 	<p><i>CIA 18988 (TPE 70 Shore A)</i></p> 	
<p><i>CIA 6076 (EPDM 70 Shore A)</i></p> 	<p><i>CIA 19978 (EPDM 70 Shore A)</i></p> 	<p><i>CIA 18736 (NBR 70 Shore A)</i></p> 	
<p><i>CIA 14089 (EPDM 63 Shore A)</i></p> 	<p><i>CIA 6142 (EPDM 70 Shore A)</i> <i>CIA 17237 (TPE 70 Shore A)</i></p> 	<p><i>CIA 6055 (EPDM 70 Shore A)</i></p> 	

CIA 6204 (EPDM 70 Shore A)

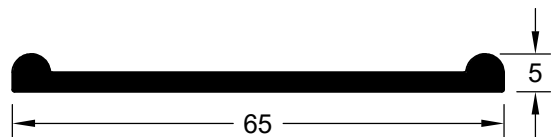

CIA 6195 (EPDM 70 Shore A)

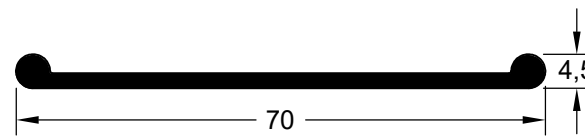

CIA 16474 (TPE 70 Shore A)

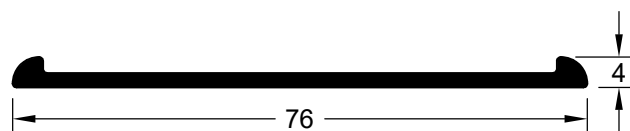

CIA 7052 (TPE 70 Shore A)

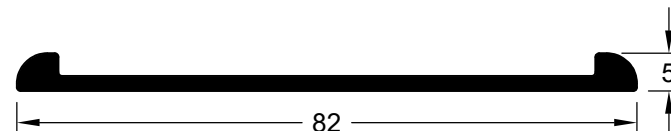

CIA 6352 (EPDM 70 Shore A)
CIA 16564 (TPE 70 Shore A)

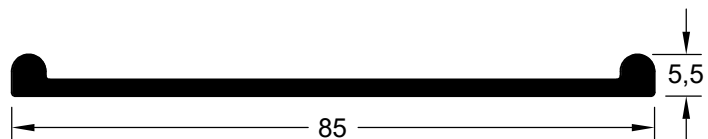

CIA 6343 (EPDM 70 Shore A)

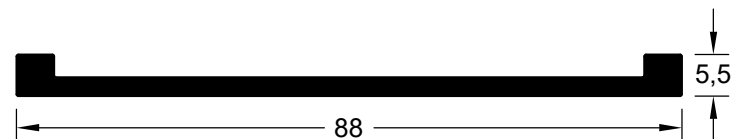

CIA 7051 (TPE 70 Shore A)

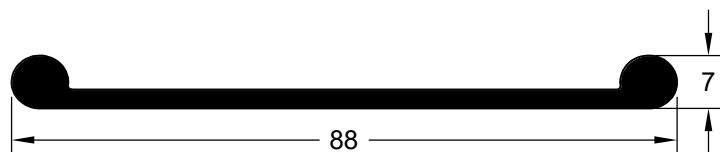

CIA 6194 (EPDM 70 Shore A)

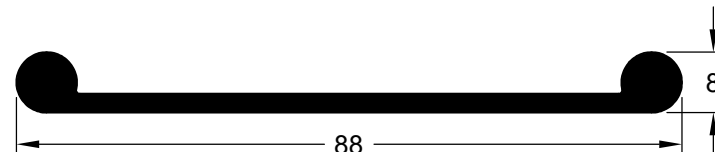

CIA 6237 (EPDM 80 Shore A)
CIA 16801 (TPE 70 Shore A)

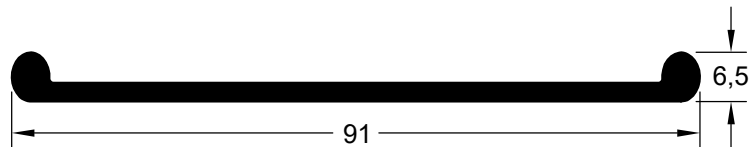

CIA 7050 (TPE 70 Shore A)

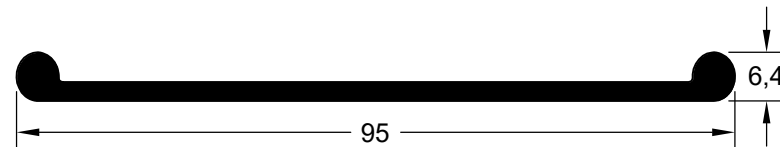

CIA 6364 (EPDM 70 Shore A)

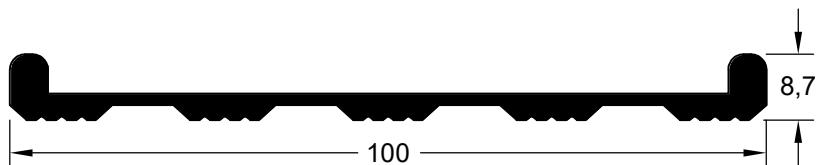

CIA 6306 (EPDM 80 Shore A)

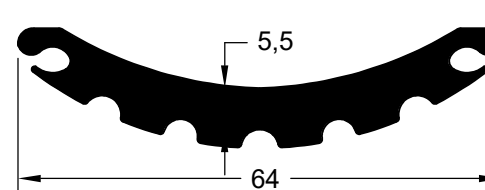

CIA 14579 (TPE 65 Shore A)

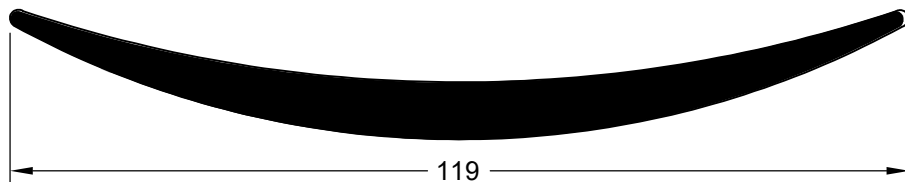

CIA 7026 (TPE 85 Shore A)

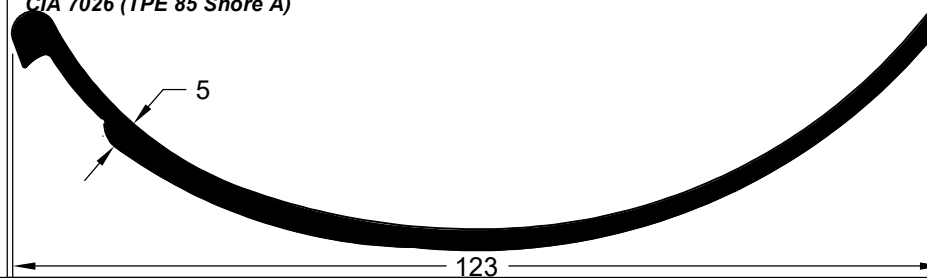

CIA 17518 (EPDM 70 Shore A)

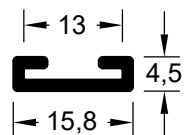

CIA 17517 (EPDM 70 Shore A)

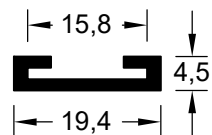

CIA 17516 (EPDM 70 Shore A)

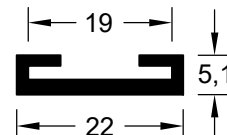

CIA 6371 (CR 70 Shore A)

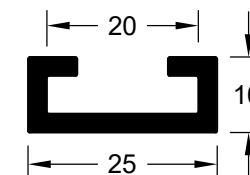

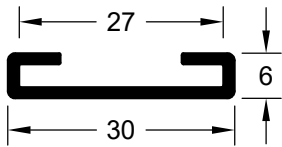
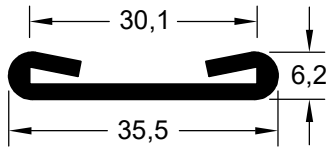
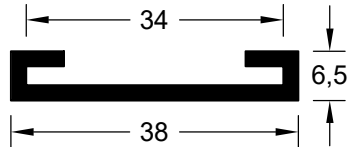
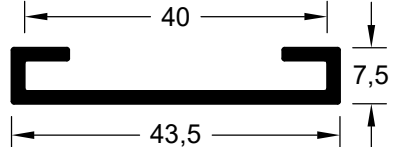
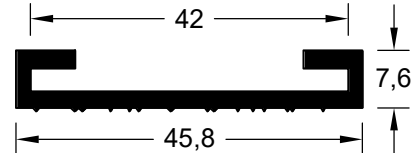
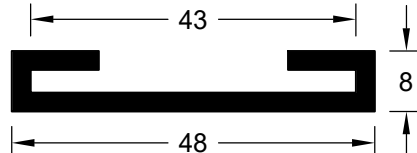
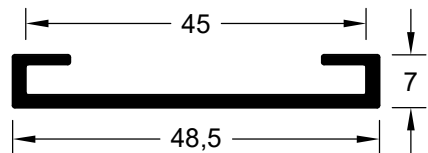
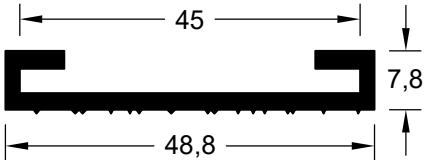
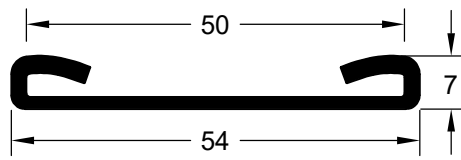
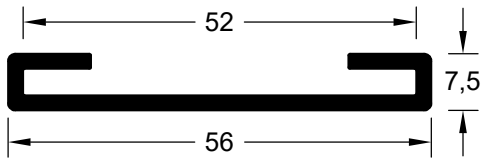
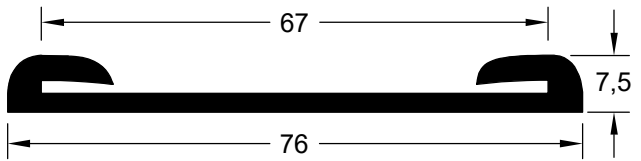
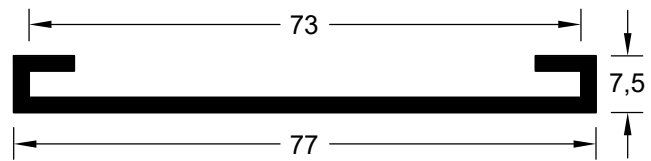

<p><i>CIA 6366 (EPDM 70 Shore A)</i></p> 	<p><i>CIA 17172 (TPE 55 Shore A)</i></p> 	<p><i>CIA 17935 (EPDM 70 Shore A)</i></p> 	<p><i>CIA 6150 (EPDM 70 Shore A)</i></p> 
<p><i>CIA 16707 (EPDM 70 Shore A)</i></p> 	<p><i>CIA 17924 (NBR 70 Shore A)</i></p> 	<p><i>CIA 6151 (EPDM 70 Shore A)</i></p> 	
<p><i>CIA 16708 (NBR 70 Shore A)</i></p> 	<p><i>CIA 6127 (EPDM 70 Shore A)</i></p> 	<p><i>CIA 6365 (EPDM 70 Shore A)</i></p> 	
<p><i>CIA 19386 (EPDM 70 Shore A)</i></p> 		<p><i>CIA 15980 (EPDM 70 Shore A)</i></p> 	

PERFIL MACIÇO

<p>CIA 15623 (EPDM 70 Shore A)</p> <p>77 82 7</p>	<p>CIA 6302 (EPDM 70 Shore A)</p> <p>99 103 8,5</p>
<p>CIA 17387 (TPE 70 Shore A)</p> <p>83,5 86,3 4,6</p>	<p>CIA 16817 (NR 75 Shore A)</p> <p>30 40 19,8</p>
<p>CIA 17760 (EPDM 70 Shore A)</p> <p>36 48 20</p>	<p>CIA 19434 (EPDM 70 Shore A)</p> <p>37 50 14,8</p>
<p>CIA 6074 (EPDM 70 Shore A)</p> <p>47,5 57 13</p>	<p>CIA 19955 (EPDM 70 SH A)</p> <p>67 80 14,8</p>
<p>CIA 6326 (EPDM 70 Shore A)</p> <p>88 4,2</p>	<p>CIA 6152 (EPDM 80 Shore A) CIA 16679 (NBR 70 Shore A)</p> <p>100 3</p>

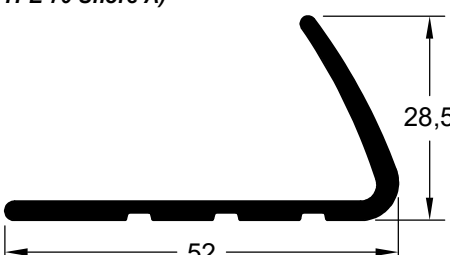
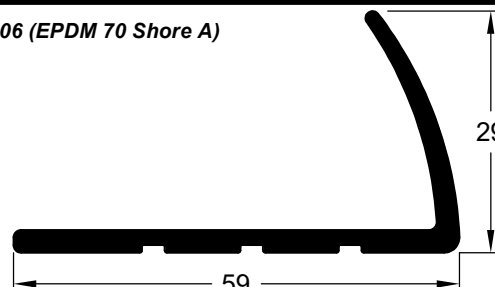
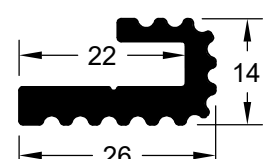
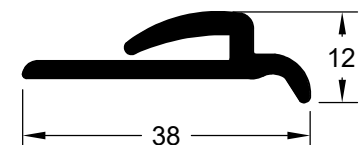
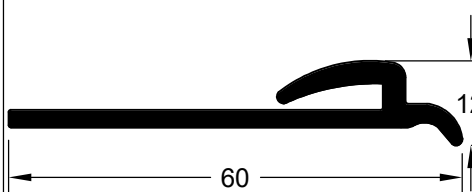
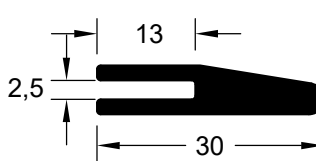
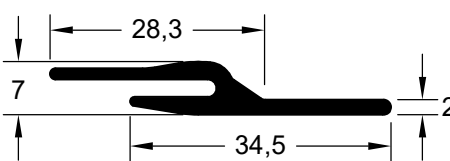
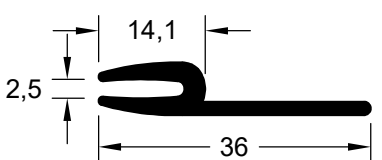
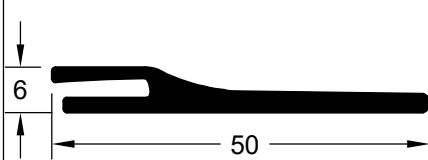
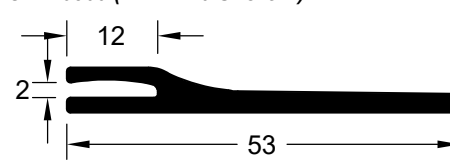
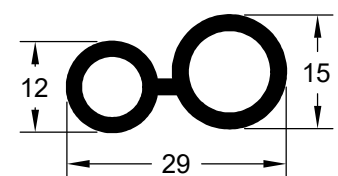
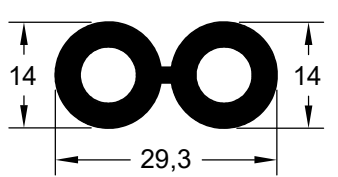
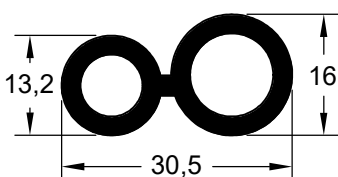
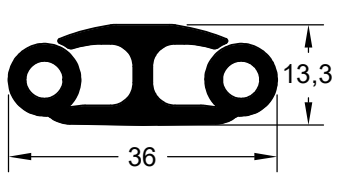
<p><i>CIA 7074 (TPE 80 Shore A)</i></p>	<p><i>CIA 14260 (EPDM 70 Shore A)</i></p>	<p><i>CIA 18309 (EPDM 80 Shore A)</i></p>	
<p><i>CIA 15887 (EPDM 70 Shore A)</i> <i>CIA 16587 (TPE 85 Shore A)</i></p>	<p><i>CIA 18416 (TPE 90 Shore A)</i></p>	<p><i>CIA 6068 (EPDM 70 Shore A)</i></p>	
<p><i>CIA 16000 (EPDM 80 Shore A)</i></p>	<p><i>CIA 7016 (TPE 70 Shore A)</i></p>	<p><i>CIA 6228 (EPDM 80 Shore A)</i></p>	
<p><i>CIA 18601 (EPDM 70 Shore A)</i></p>	<p><i>CIA 6124 (EPDM 63 Shore A)</i></p>	<p><i>CIA 17332 (NBR 70 Shore A)</i></p>	<p><i>CIA 16326 (EPDM 63 Shore A)</i></p>

<p><i>CIA 7018 (TPE 70 Shore A)</i></p> 	<p><i>CIA 6206 (EPDM 70 Shore A)</i></p> 	<p><i>CIA 6454 (EPDM 70 Shore A)</i></p> 	
<p><i>CIA 14954 (EPDM 80 Shore A)</i></p> 	<p><i>CIA 6058 (EPDM 80 Shore A)</i></p> 	<p><i>CIA 16266 (EPDM 70 Shore A)</i></p> 	<p><i>CIA 18815 (EPDM 63 Shore A)</i></p> 
<p><i>CIA 6430 (EPDM 80 Shore A)</i></p> 	<p><i>CIA 17946 (TPE 85 Shore A)</i></p> 	<p><i>CIA 14840 (EPDM 80 Shore A)</i> <i>CIA 16300 (EPDM 70 Shore A)</i></p> 	<p><i>CIA 15883 (EPDM 70 Shore A)</i></p> 
<p><i>CIA 6020 (EPDM 63 Shore A)</i></p> 	<p><i>CIA 18797 (EPDM 70 Shore A)</i></p> 	<p><i>CIA 18586 (EPDM 70 Shore A)</i></p> 	<p><i>CIA 6234 (EPDM 70 Shore A)</i></p> 

PERFIL MACIÇO

<p><i>CIA 6188 (EPDM 80 Shore A)</i></p>	<p><i>CIA 6148 (EPDM 80 Shore A)</i></p>	<p><i>CIA 6504 (EPDM 55 Shore A)</i></p>	<p><i>CIA 6098 (EPDM 80 Shore A)</i></p>
<p><i>CIA 6334 (EPDM 80 Shore A)</i></p>	<p><i>CIA 6330 (EPDM 80 Shore A)</i></p>	<p><i>CIA 6295 (EPDM 80 Shore A)</i></p>	
<p><i>CIA 19970 (EPDM 70 Shore A)</i></p>	<p><i>CIA 6308 (EPDM 63 Shore A)</i></p>	<p><i>CIA 7058 (TPE 70 Shore A)</i></p>	<p><i>CIA 6026 (EPDM 80 Shore A)</i></p>
<p><i>CIA 6030 (EPDM 70 Shore A)</i></p>	<p><i>CIA 6029 (EPDM 70 Shore A)</i></p>	<p><i>CIA 6027 (EPDM 70 Shore A)</i></p>	<p><i>CIA 6472 (EPDM 80 Shore A)</i></p>

PERFIL MACIÇO

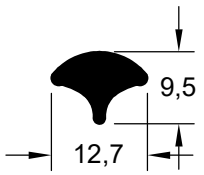
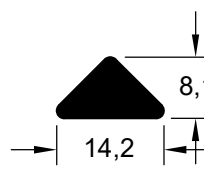
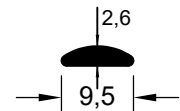
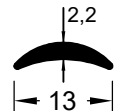
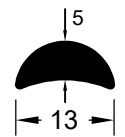
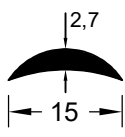
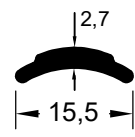
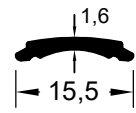
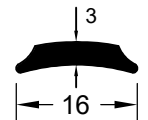
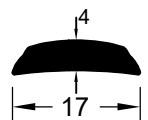
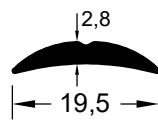
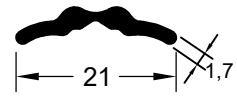
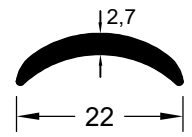
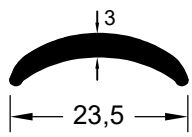
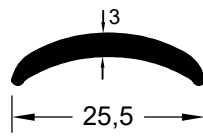
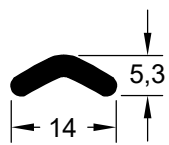
<p><i>CIA 6028 (EPDM 80 Shore A)</i></p> 	<p><i>CIA 6480 (EPDM 63 Shore A)</i></p> 	<p><i>CIA 7054 (TPE 70 Shore A)</i></p> 	<p><i>CIA 7048 (TPE 70 Shore A)</i></p> 
<p><i>CIA 6338 (EPDM 70 Shore A)</i></p> 	<p><i>CIA 6048 (EPDM 80 Shore A)</i> <i>CIA 7075 (TPE 70 Shore A)</i></p> 	<p><i>CIA 7002 (TPE 70 Shore A)</i></p> 	<p><i>CIA 14833 (TPE 85 Shore A)</i></p> 
<p><i>CIA 6265 (EPDM 80 Shore A)</i></p> 	<p><i>CIA 6197 (EPDM 80 Shore A)</i></p> 	<p><i>CIA 6238 (EPDM 80 Shore A)</i> <i>CIA 7065 (TPE 70 Shore A)</i></p> 	<p><i>CIA 7041 (TPE 70 Shore A)</i></p> 
<p><i>CIA 7057 (TPE 70 Shore A)</i></p> 	<p><i>CIA 7023 (TPE 70 Shore A)</i></p> 	<p><i>CIA 7019 (TPE 70 Shore A)</i></p> 	<p><i>CIA 6241 (EPDM 80 Shore A)</i></p> 

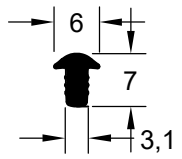
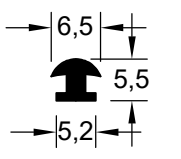
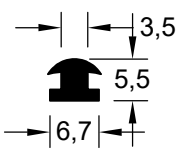
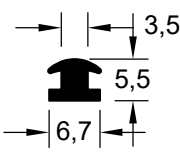
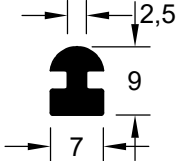
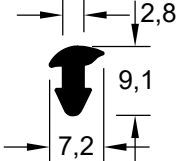
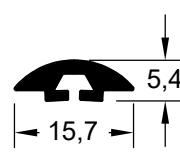
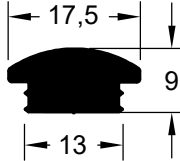
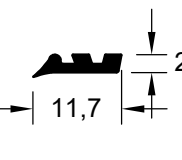
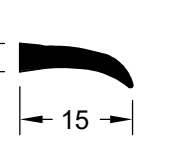
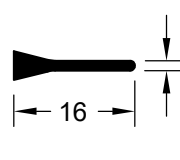
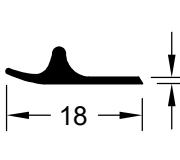
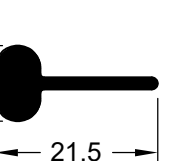
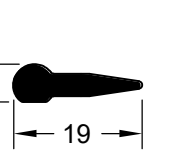
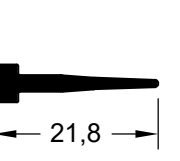
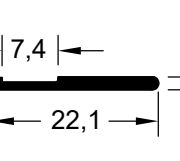
<p>CIA 15711 (TPE 60 Shore A)</p> 	<p>CIA 7069 (TPE 70 Shore A)</p> 	<p>CIA 14832 (TPE 90 Shore A)</p> 	<p>CIA 16721 (EPDM 70 Shore A)</p> 
<p>CIA 16238 (EPDM 63 Shore A)</p> 	<p>CIA 17222 (EPDM 70 Shore A)</p> 	<p>CIA 17838 (EPDM 80 Shore A)</p> 	<p>CIA 15780 (EPDM 80 Shore A)</p> 
<p>CIA 6081 (EPDM 70 Shore A)</p> 	<p>CIA 14250 (EPDM 70 Shore A)</p> 	<p>CIA 6173 (EPDM 70 Shore A)</p> 	<p>CIA 16212 (EPDM 63 Shore A)</p> 
<p>CIA 7031 (TPE 70 Shore A)</p> 	<p>CIA 16867 (EPDM 70 Shore A)</p> 	<p>CIA 16618 (TPE 70 Shore A)</p> 	<p>CIA 16746 (TPE 60 Shore A)</p> 

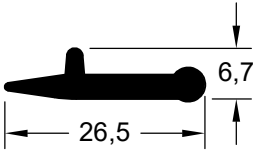
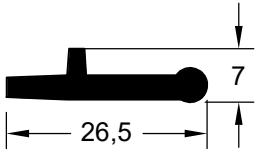
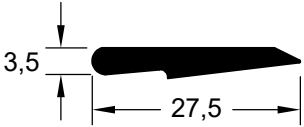
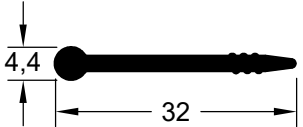
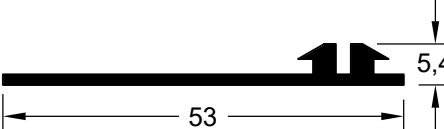
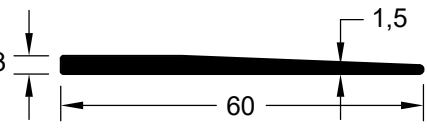
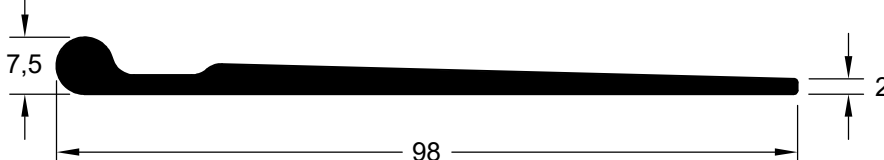
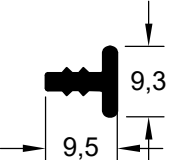
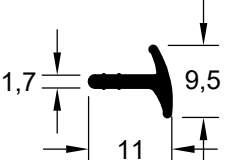
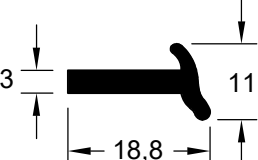
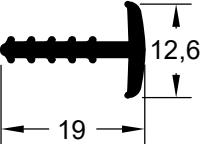
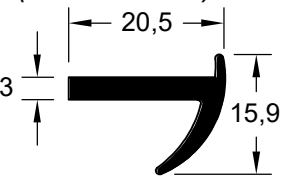
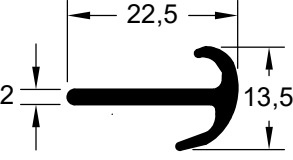
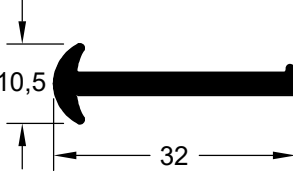
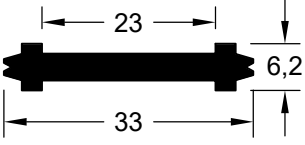
<p><i>CIA 19378 (TPE 70 Shore A)</i></p> 	<p><i>CIA 18858 (EPDM 63 Shore A)</i></p> 	<p><i>CIA 7083 (TPE 65 Shore A)</i></p> 	<p><i>CIA 14317 (SBR+NR 75 Shore A)</i></p> 
<p><i>CIA 18991 (EPDM 72 Shore A)</i></p> 	<p><i>CIA 6309 (EPDM 80 Shore A)</i></p> 	<p><i>CIA 6316 (EPDM 80 Shore A)</i></p> 	
<p><i>CIA 6125 (EPDM 80 Shore A)</i></p> 	<p><i>CIA 6301 (EPDM 63 Shore A)</i></p> 	<p><i>CIA 6428 (EPDM 80 Shore A)</i></p> 	<p><i>CIA 7066 (TPE 70 Shore A)</i></p> 
<p><i>CIA 6440 (EPDM 80 Shore A)</i></p> 	<p><i>CIA 19624 (TPE 70 Shore A)</i></p> 	<p><i>CIA 6095 (EPDM 70 Shore A)</i></p> 	<p><i>CIA 6084 (EPDM 80 Shore A)</i></p> 

PERFIL MACIÇO

<p><i>CIA 16897 (TPE 60 Shore A)</i></p>	<p><i>CIA 6410 (EPDM 80 Shore A)</i></p>	<p><i>CIA 6383 (SBR 70 Shore A)</i></p>	<p><i>CIA 6412 (EPDM 63 Shore A)</i></p>
<p><i>CIA 6052 (EPDM 63 Shore A)</i></p>	<p><i>CIA 6394 (NBR 70 Shore A)</i></p>	<p><i>CIA 6130 (EPDM 70 Shore A)</i></p>	<p><i>CIA 18186 (EPDM 70 Shore A)</i></p>
<p><i>CIA 6117 (NBR 70 Shore A)</i></p>	<p><i>CIA 6457 (EPDM 70 Shore A)</i></p>	<p><i>CIA 6133 (EPDM 70 Shore A)</i></p>	<p><i>CIA 14453 (NR 50 Shore A)</i></p>
<p><i>CIA 14365 (NR 50 Shore A)</i></p>	<p><i>CIA 14454 (NR 50 Shore A)</i></p>	<p><i>CIA 17327 (EPDM 80 Shore A)</i></p>	<p><i>CIA 19475 (EPDM 80 Shore A)</i></p>

PERFIL MACIÇO

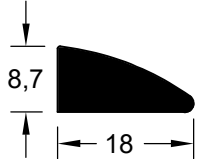
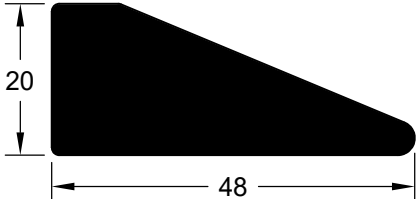
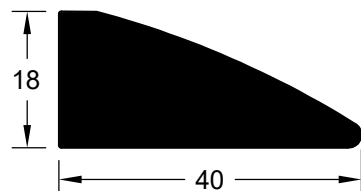
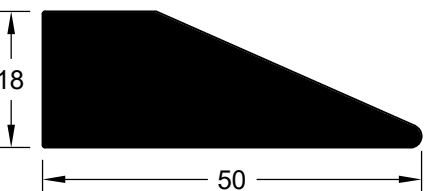
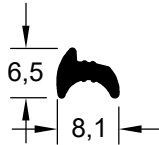
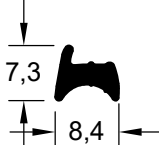
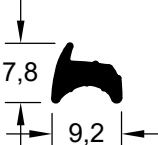
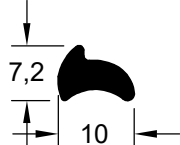
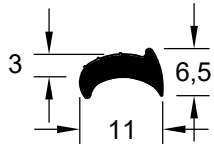
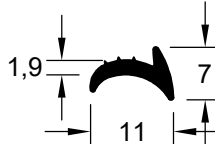
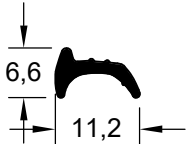
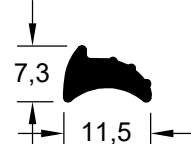
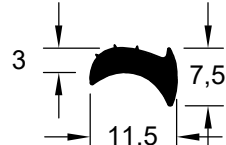
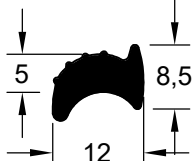
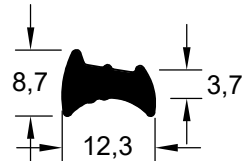
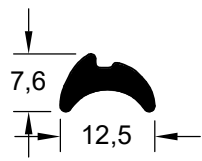
<p>CIA 18823 (EPDM 63 Shore A)</p> 	<p>CIA 6322 (EPDM 70 Shore A)</p> 	<p>CIA 6101 (SBR 70 Shore A) CIA 6182 (EPDM 80 Shore A)</p> 	<p>CIA 6216 (EPDM 70 Shore A)</p> 
<p>CIA 18105 (EPDM 63 Shore A)</p> 	<p>CIA 18059 (EPDM 63 Shore A)</p> 	<p>CIA 18156 (EPDM 63 Shore A)</p> 	<p>CIA 18158 (EPDM 63 Shore A)</p> 
<p>CIA 6044 (EPDM 80 Shore A)</p> 	<p>CIA 6043 (EPDM 80 Shore A)</p> 	<p>CIA 18155 (EPDM 63 Shore A)</p> 	<p>CIA 18157 (EPDM 63 Shore A)</p> 
<p>CIA 6073 (EPDM 80 Shore A)</p> 	<p>CIA 6293 (EPDM 80 Shore A)</p> 	<p>CIA 18232 (EPDM 63 Shore A)</p> 	<p>CIA 18234 (EPDM 63 Shore A)</p> 

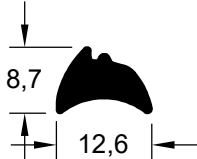
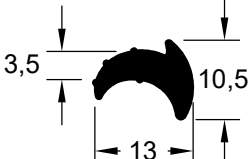
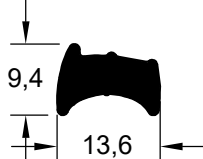
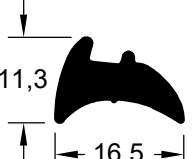
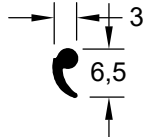
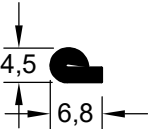
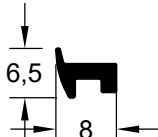
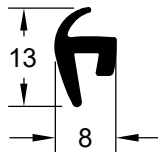
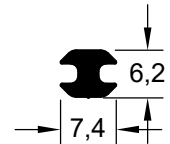
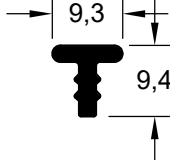
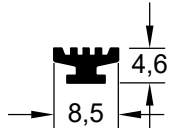
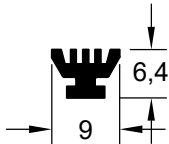
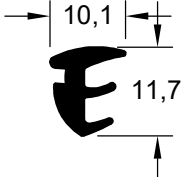
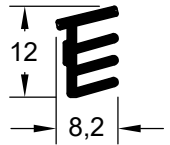
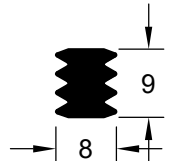
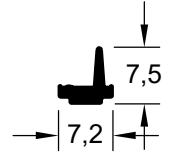
<p><i>CIA 18154 (EPDM 63 Shore A)</i></p> 	<p><i>CIA 6406 (EPDM 80 Shore A)</i></p> 	<p><i>CIA 18233 (EPDM 63 Shore A)</i></p> 	<p><i>CIA 18230 (EPDM 63 Shore A)</i></p> 
<p><i>CIA 6242 (EPDM 80 Shore A)</i></p> 	<p><i>CIA 17488 (SILICONE 55 Shore A)</i></p> 	<p><i>CIA 18955 (EPDM 80 Shore A)</i></p> 	<p><i>CIA 17704 (EPDM 70 Shore A)</i></p> 
<p><i>CIA 18414 (TPE 90 Shore A)</i></p> 	<p><i>CIA 18126 (TPE 70 Shore A)</i></p> 	<p><i>CIA 18596 (EPDM 63 Shore A)</i></p> 	<p><i>CIA 18594 (EPDM 63 Shore A)</i></p> 
<p><i>CIA 18805 (EPDM 70 Shore A)</i></p> 	<p><i>CIA 18697 (EPDM 63 Shore A)</i></p> 	<p><i>CIA 18653 (EPDM 63 Shore A)</i></p> 	<p><i>CIA 6171 (EPDM 80 Shore A)</i></p> 

PERFIL MACIÇO

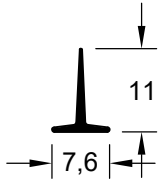
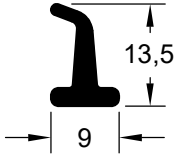
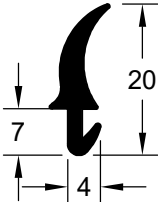
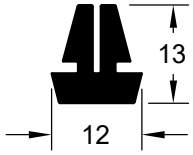
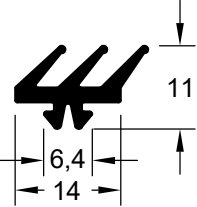
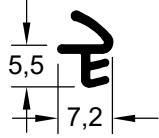
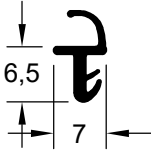
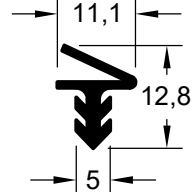
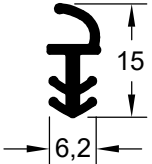
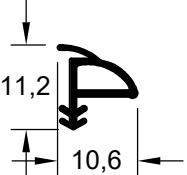
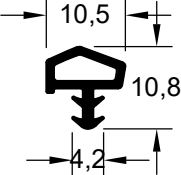
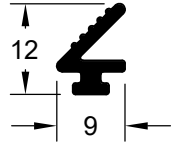
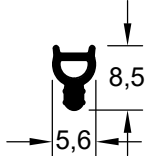
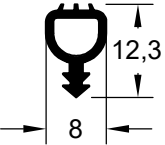
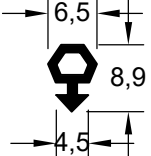
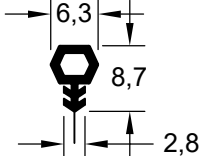
<p>CIA 6319 (EPDM 80 Shore A)</p> 	<p>CIA 18455 (EPDM 70 Shore A)</p> 	<p>CIA 6078 (EPDM 70 Shore A)</p> 	<p>CIA 6198 (EPDM 63 Shore A)</p> 
<p>CIA 6289 (EPDM 70 Shore A)</p> 	<p>CIA 7028 (TPE 60 Shore A)</p> 	<p>CIA 6189 (EPDM 80 Shore A) CIA 7033 (TPE 60 Shore A)</p> 	<p>CIA 19164 (TPE 55 Shore A)</p> 
<p>CIA 6305 (EPDM 80 Shore A)</p> 	<p>CIA 18636 (TPE 60 Shore A)</p> 	<p>CIA 7059 (TPE 60 Shore A)</p> 	<p>CIA 18231 (EPDM 63 Shore A)</p> 
<p>CIA 17994 (EPDM 55 Shore A)</p> 	<p>CIA 19601 (EPDM 70 Shore A)</p> 	<p>CIA 6158 (EPDM 80 Shore A)</p> 	<p>CIA 7020 (TPE 60 Shore A)</p> 

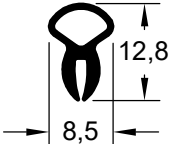
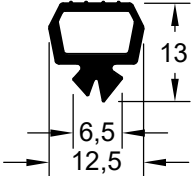
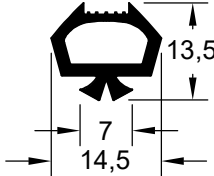
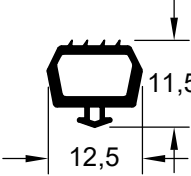
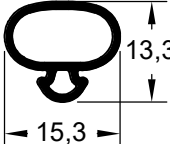
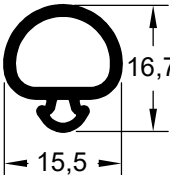
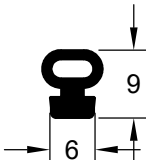
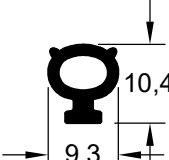
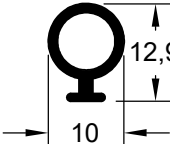
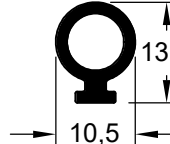
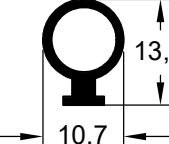
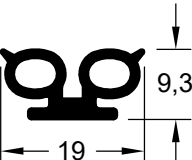
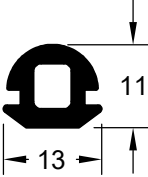
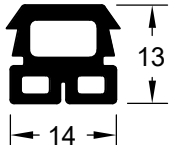
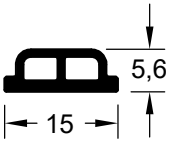
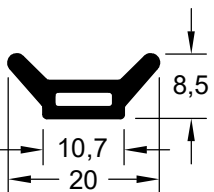
<p><i>CIA 17485 (SILICONE 55 Shore A)</i></p> 	<p><i>CIA 6246 (EPDM 70 Shore A)</i></p> 	<p><i>CIA 6153 (EPDM 70 Shore A)</i></p> 	<p><i>CIA 19459 (EPDM 70 Shore A)</i></p> 
<p><i>CIA 18703 (EPDM 80 Shore A)</i></p> 	<p><i>CIA 19585 (EPDM 72 Shore A)</i></p> 	<p><i>CIA 6416 (EPDM 63 Shore A)</i></p> 	<p><i>CIA 18332 (EPDM 63 Shore A)</i></p> 
<p><i>CIA 19294 (EPDM 63 Shore A)</i></p> 	<p><i>CIA 18333 (EPDM 63 Shore A)</i></p> 	<p><i>CIA 19911 (EPDM 75 Shore A)</i></p> 	<p><i>CIA 18331 (EPDM 63 Shore A)</i></p> 
<p><i>CIA 6172 (EPDM 80 Shore A)</i></p> 	<p><i>CIA 6225 (CR 70 Shore A)</i></p> 	<p><i>CIA 18652 (EPDM 63 Shore A)</i></p> 	<p><i>CIA 6303 (EPDM 80 Shore A)</i></p> 

PERFIL MACIÇO

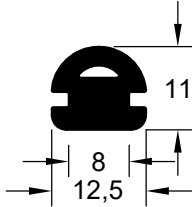
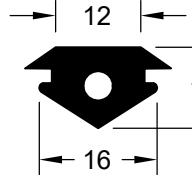
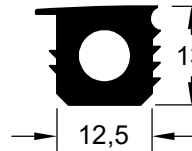
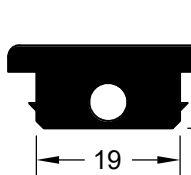
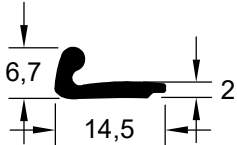
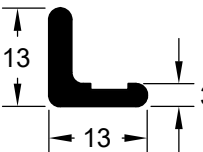
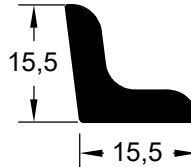
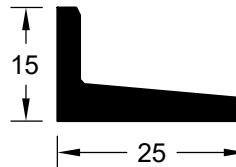
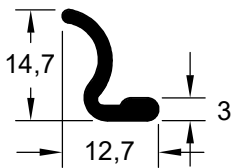
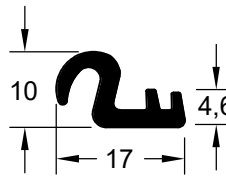
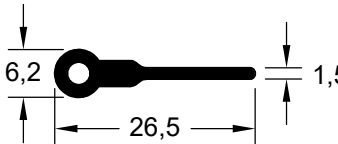
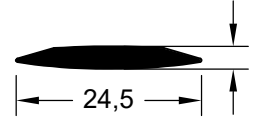
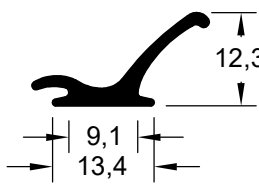
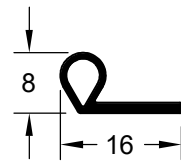
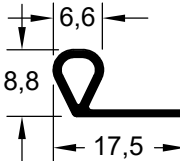
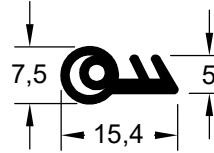
<p><i>CIA 6423 (EPDM 80 Shore A)</i></p> 	<p><i>CIA 18044 (EPDM 70 Shore A)</i></p> 	<p><i>CIA 14379 (EPDM 70 Shore A)</i></p> 	<p><i>CIA 14380 (EPDM 70 Shore A)</i></p> 
<p><i>CIA 6313 (EPDM 80 Shore A)</i></p> 	<p><i>CIA 19142 (EPDM 80 Shore A)</i></p> 	<p><i>CIA 6054 (EPDM 63 Shore A)</i></p> 	<p><i>CIA 6432 (EPDM 80 Shore A)</i></p> 
<p><i>CIA 14838 (TPE 60 Shore A)</i></p> 	<p><i>CIA 6042 (EPDM 80 Shore A)</i></p> 	<p><i>CIA 6439 (EPDM 80 Shore A)</i></p> 	<p><i>CIA 17974 (EPDM 70 Shore A)</i></p> 
<p><i>CIA 17969 (TPE 85 Shore A)</i></p> 	<p><i>CIA 18886 (EPDM 63 Shore A)</i></p> 	<p><i>CIA 17012 (EPDM 63 Shore A)</i></p> 	<p><i>CIA 6181 (EPDM 63 Shore A)</i></p> 

PERFIL MACIÇO

<p>CIA 6089 (EPDM 80 Shore A)</p>	<p>CIA 6207 (EPDM 80 Shore A)</p>	<p>CIA 6485 (EPDM 80 Shore A)</p>	<p>CIA 6470 (EPDM 80 Shore A)</p>
<p>CIA 6482 (EPDM 80 Shore A)</p>	<p>CIA 6315 (EPDM 70 Shore A)</p>	<p>CIA 6355 (EPDM 70 Shore A)</p>	<p>CIA 6385 (EPDM 70 Shore A)</p>
<p>CIA 17072 (EPDM 70 Shore A)</p>	<p>CIA 18089 (EPDM 72 Shore A)</p>	<p>CIA 16901 (EPDM 72 Shore A)</p>	
<p>CIA 19514 (EPDM 72 Shore A)</p>	<p>CIA 18088 (EPDM 70 Shore A)</p>	<p>CIA 19112 (EPDM 72 Shore A)</p>	

PERFIL MACIÇO

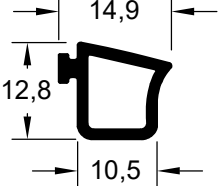
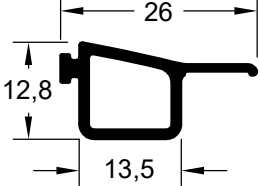
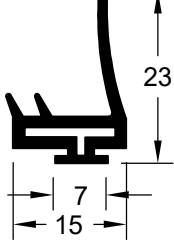
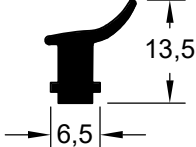
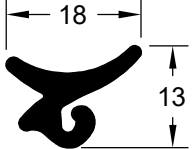
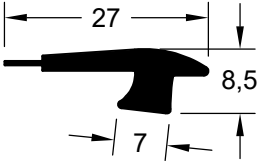
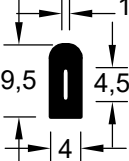
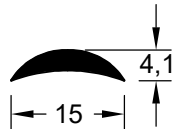
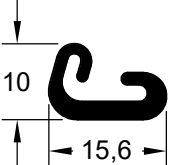
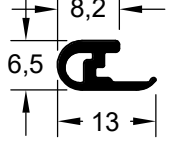
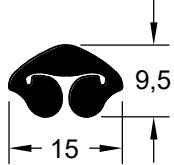
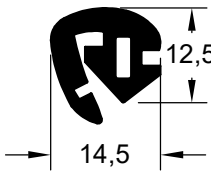
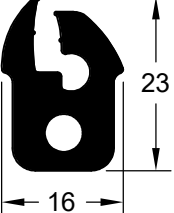
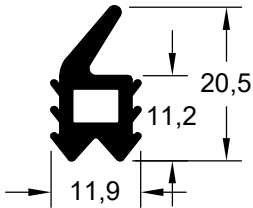
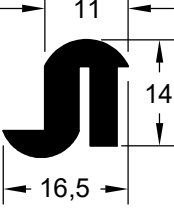
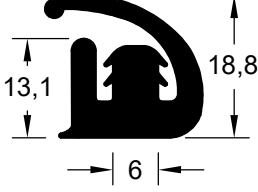
<p>CIA 19111 (EPDM 72 Shore A)</p> 	<p>CIA 19619 (EPDM 72 Shore A)</p> 	<p>CIA 6128 (EPDM 80 Shore A)</p> 	<p>CIA 6157 (EPDM 80 Shore A)</p> 
<p>CIA 6217 (SBR 70 Shore A)</p> 	<p>CIA 6373 (EPDM 80 Shore A)</p> 	<p>CIA 19165 (TPE 35 Shore A)</p> 	<p>CIA 17995 (EPDM 80 Shore A)</p> 
<p>CIA 18057 (EPDM 70 Shore A)</p> 	<p>CIA 16574 (EPDM 80 Shore A)</p> 	<p>CIA 18127 (EPDM 80 Shore A)</p> 	<p>CIA 6337 (EPDM 80 Shore A)</p> 
<p>CIA 18727 (EPDM 80 Shore A)</p> 	<p>CIA 18868 (NBR 70 Shore A)</p> 	<p>CIA 6465 (EPDM 70 Shore A)</p> 	<p>CIA 16436 (EPDM 70 Shore A)</p> 

PERFIL MACIÇO

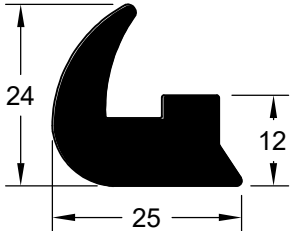
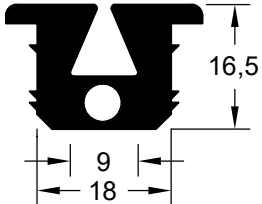
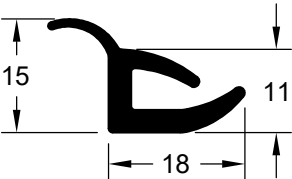
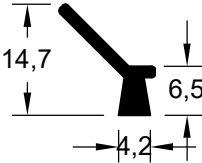
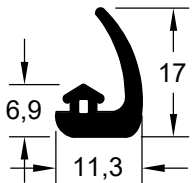
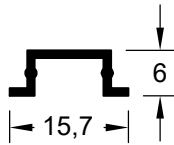
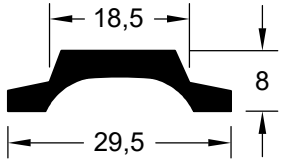
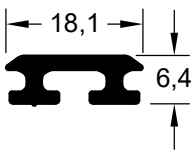
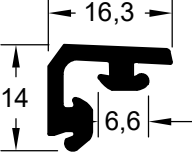
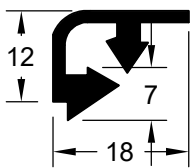
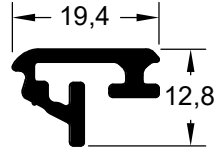
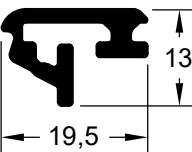
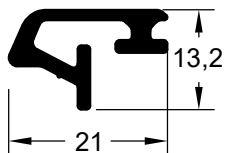
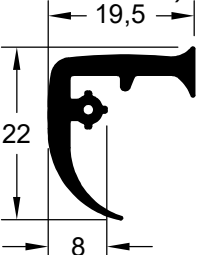
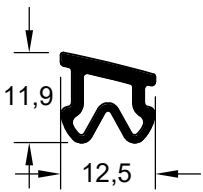
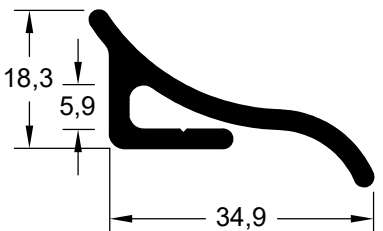
<p>CIA 6456 (EPDM 63 Shore A)</p> 	<p>CIA 14381 (EPDM 70 Shore A)</p> 	<p>CIA 7070 (TPE 70 Shore A)</p> 	<p>CIA 6243 (EPDM 80 Shore A)</p> 
<p>CIA 6399 (EPDM 80 Shore A)</p> 	<p>CIA 18056 (EPDM 70 Shore A)</p> 	<p>CIA 6492 (EPDM 80 Shore A)</p> 	<p>CIA 18413 (TPE 90 Shore A)</p> 
<p>CIA 15251 (TPE 85 Shore A)</p> 	<p>CIA 14117 (TPE 80 Shore A)</p> 	<p>CIA 18412 (TPE 90 Shore A)</p> 	<p>CIA 14413 (TPE 90 Shore A)</p> 
<p>CIA 18415 (TPE 90 Shore A)</p> 	<p>CIA 6447 (EPDM 70 Shore A)</p> 	<p>CIA 18080 (EPDM 80 Shore A)</p> 	<p>CIA 16536 (EPDM 80 Shore A)</p> 

PERFIL MACIÇO

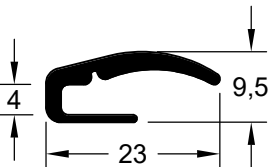
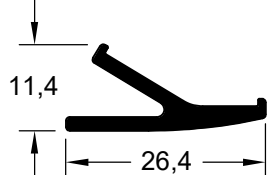
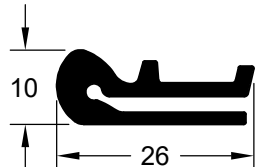
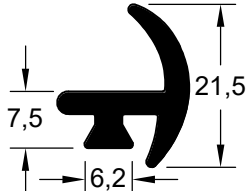
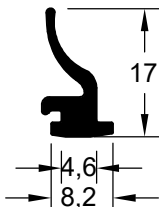
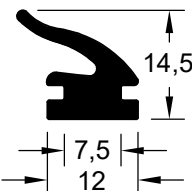
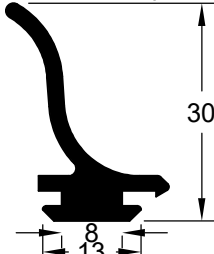
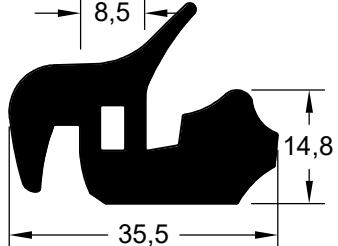
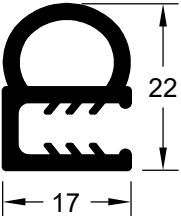
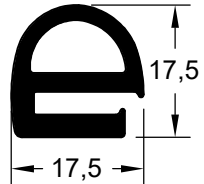
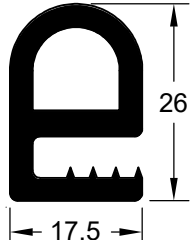
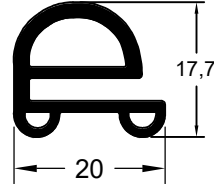
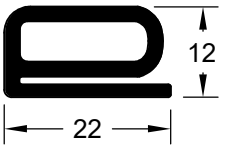
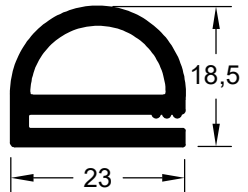
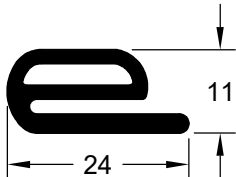
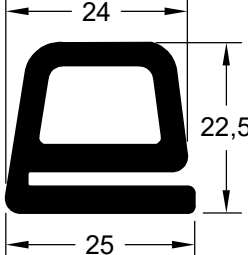
<p><i>CIA 15819 (TPE 60 Shore A)</i></p> 	<p><i>CIA 19881 (EPDM 80 Shore A)</i></p> 	<p><i>CIA 6370 (CR 70 Shore A)</i></p> 	<p><i>CIA 6106 (EPDM 80 Shore A)</i></p> 
<p><i>CIA 19091 (EPDM 70 Shore A)</i></p> 	<p><i>CIA 6424 (EPDM 80 Shore A)</i></p> 	<p><i>CIA 16535 (EPDM 80 Shore A)</i></p> 	<p><i>CIA 6378 (EPDM 63 Shore A)</i></p> 
<p><i>CIA 18861 (EPDM 80 Shore A)</i></p> 	<p><i>CIA 6400 (EPDM 70 Shore A)</i></p> 	<p><i>CIA 18587 (EPDM 70 Shore A)</i></p> 	<p><i>CIA 6180 (EPDM 80 Shore A)</i></p> 
<p><i>CIA 6179 (EPDM 80 Shore A)</i></p> 	<p><i>CIA 6333 (EPDM 70 Shore A)</i></p> 	<p><i>CIA 7038 (TPE 70 Shore A)</i></p> 	<p><i>CIA 6161 (EPDM 70 Shore A)</i></p> 

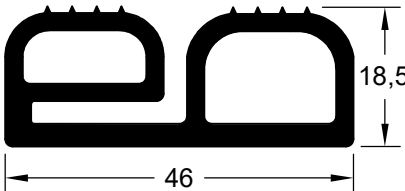
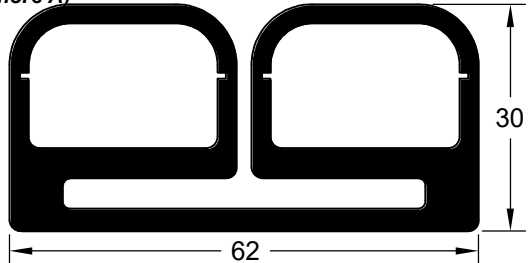
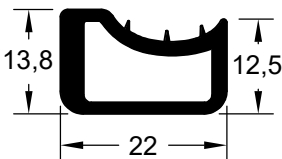
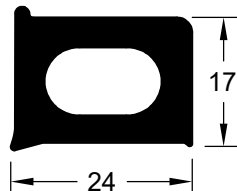
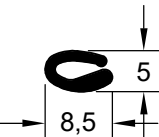
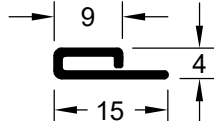
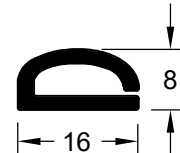
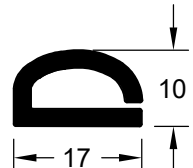
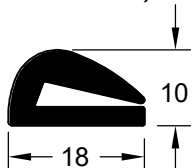
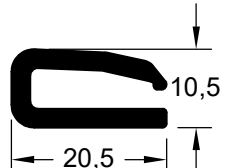
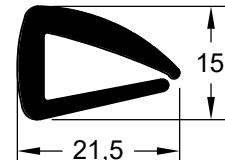
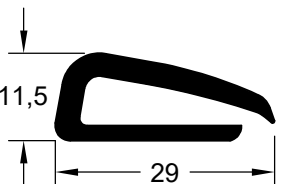
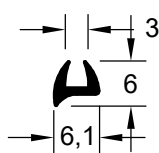
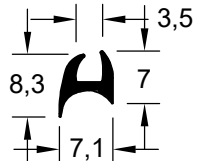
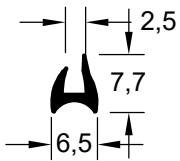

PERFIL MACIÇO

<p>CIA 6079 (EPDM 70 Shore A)</p> 	<p>CIA 6227 (EPDM 70 Shore A)</p> 	<p>CIA 6129 (EPDM 70 Shore A)</p> 	
<p>CIA 6132 (EPDM 70 Shore A)</p> 	<p>CIA 6349 (EPDM 80 Shore A)</p> 	<p>CIA 6235 (EPDM 80 Shore A)</p> 	<p>CIA 6111 (EPDM 63 Shore A)</p> 
<p>CIA 6112 (EPDM 80 Shore A)</p> 	<p>CIA 6353 (EPDM 80 Shore A) CIA 19329 (EPDM 70 Shore A)</p> 	<p>CIA 7014 (TPE 70 Shore A)</p> 	<p>CIA 6288 (EPDM 80 Shore A)</p> 
<p>CIA 14836 (TPE 60 Shore A)</p> 	<p>CIA 18521 (EPDM 80 Shore A)</p> 	<p>CIA 6469 (EPDM 80 Shore A)</p> 	<p>CIA 6434 (EPDM 80 Shore A)</p> 

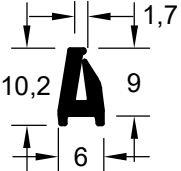
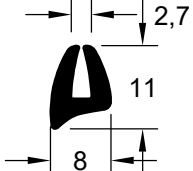
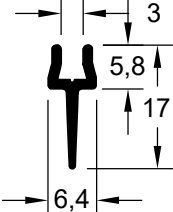
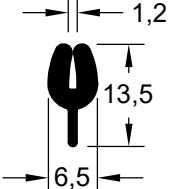
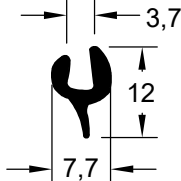
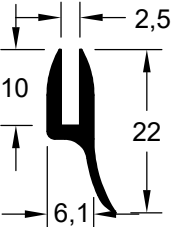
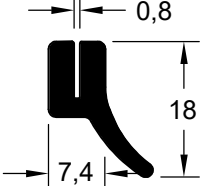
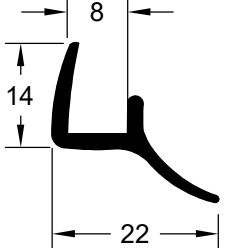
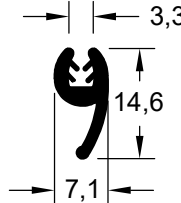
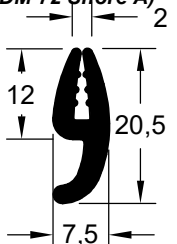
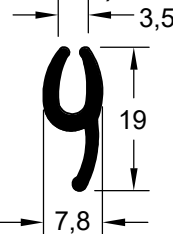
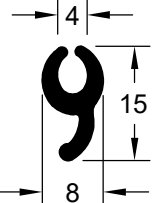
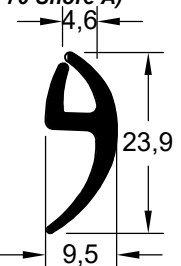
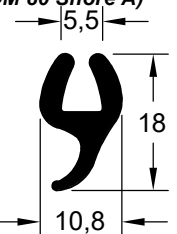
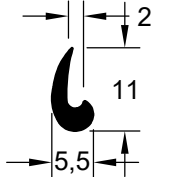
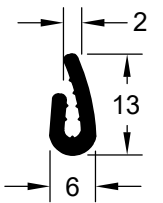
PERFIL MACIÇO

<p>CIA 6075 (EPDM 70 Shore A)</p> 	<p>CIA 6348 (EPDM 80 Shore A)</p> 	<p>CIA 6170 (EPDM 80 Shore A)</p> 	<p>CIA 6266 (EPDM 70 Shore A)</p> 
<p>CIA 14114 (EPDM 70 Shore A)</p> 	<p>CIA 14450 (EPDM 80 Shore A)</p> 	<p>CIA 6143 (EPDM 70 Shore A)</p> 	<p>CIA 6490 (EPDM 80 Shore A)</p> 
<p>CIA 17173 (TPE 70 Shore A)</p> 	<p>CIA 19938 (EPDM 72 Shore A)</p> 	<p>CIA 6335 (EPDM 80 Shore A) CIA 7009 (TPE 70 Shore A)</p> 	<p>CIA 6391 (EPDM 80 Shore A)</p> 
<p>CIA 7004 (TPE 70 Shore A)</p> 	<p>CIA 6178 (EPDM 80 Shore A)</p> 	<p>CIA 14526 (EPDM 80 Shore A)</p> 	<p>CIA 6509 (EPDM 70 Shore A)</p> 

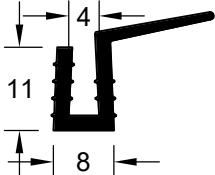
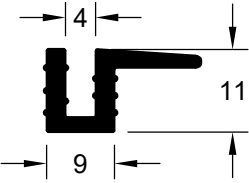
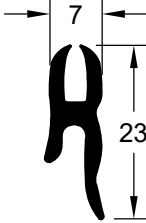
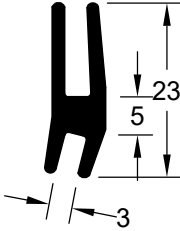
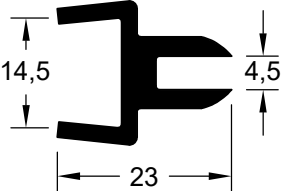
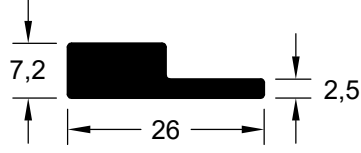
PERFIL MACIÇO

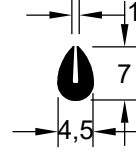
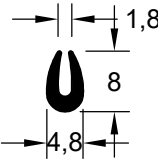
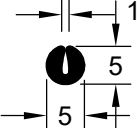
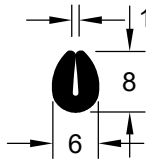
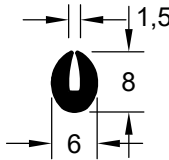
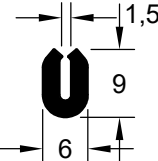
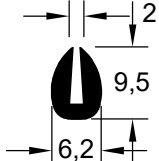
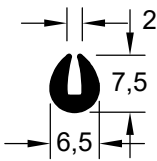
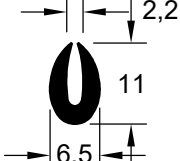
<p><i>CIA 6462 (EPDM 80 Shore A)</i></p> 	<p><i>CIA 6291 (EPDM 80 Shore A)</i></p> 	<p><i>CIA 6220 (EPDM 70 Shore A)</i></p> 	<p><i>CIA 14088 (EPDM 70 Shore A)</i></p> 
<p><i>CIA 15048 (TPE 100 Shore A)</i></p> 	<p><i>CIA 6368 (CR 70 Shore A)</i></p> 	<p><i>CIA 17546 (NBR 80 Shore A)</i></p> 	<p><i>CIA 6032 (EPDM 70 Shore A)</i> <i>CIA 15234 (TPE 70 Shore A)</i></p> 
<p><i>CIA 7030 (TPE 70 Shore A)</i></p> 	<p><i>CIA 18174 (EPDM 70 Shore A)</i></p> 	<p><i>CIA 6045 (EPDM 70 Shore A)</i> <i>CIA 7080 (TPE 70 Shore A)</i></p> 	<p><i>CIA 6061 (EPDM 70 Shore A)</i></p> 
<p><i>CIA 18317 (EPDM 70 Shore A)</i></p> 	<p><i>CIA 14578 (TPE 60 Shore A)</i></p> 	<p><i>CIA 6063 (EPDM 70 Shore A)</i></p> 	<p><i>CIA 6035 (EPDM 80 Shore A)</i> <i>CIA 7078 (TPE 70 Shore A)</i></p> 

PERFIL MACIÇO

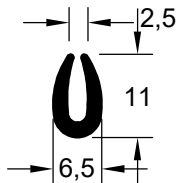
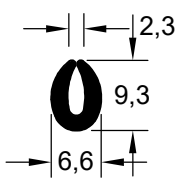
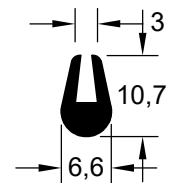
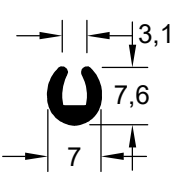
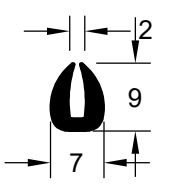
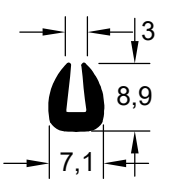
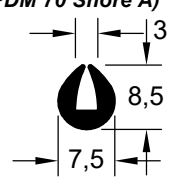
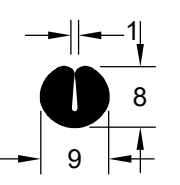
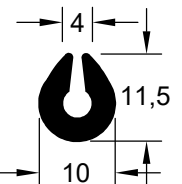
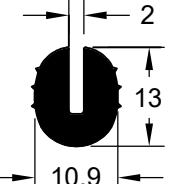
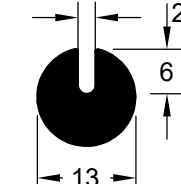
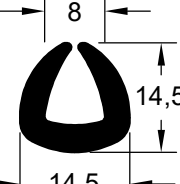
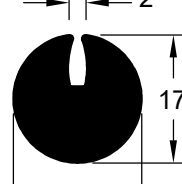
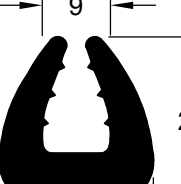
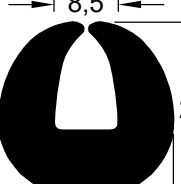
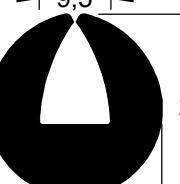
<p><i>CIA 7008 (TPE 70 Shore A)</i></p> 	<p><i>CIA 17482 (TPE 60 Shore A)</i></p> 	<p><i>CIA 19567 (EPDM 70 Shore A)</i></p> 	<p><i>CIA 14835 (TPE 60 Shore A)</i></p> 
<p><i>CIA 6382 (EPDM 70 Shore A)</i></p> 	<p><i>CIA 6033 (EPDM 70 Shore A)</i></p> 	<p><i>CIA 6327 (EPDM 63 Shore A)</i> <i>CIA 14518 (EPDM 70 Shore A)</i></p> 	<p><i>CIA 16666 (TPE 70 Shore A)</i></p> 
<p><i>CIA 14170 (EPDM 80 Shore A)</i></p> 	<p><i>CIA 6174 (EPDM 70 Shore A)</i></p> 	<p><i>CIA 6072 (NBR 70 Shore A)</i></p> 	<p><i>CIA 6102 (EPDM 80 Shore A)</i></p> 
<p><i>CIA 6223 (NBR 70 Shore A)</i></p> 	<p><i>CIA 6080 (EPDM 63 Shore A)</i></p> 	<p><i>CIA 6286 (EPDM 70 Shore A)</i></p> 	<p><i>CIA 6300 (EPDM 80 Shore A)</i></p> 

PERFIL MACIÇO

<p><i>CIA 6224 (EPDM 80 Shore A)</i></p>	<p><i>CIA 6244 (EPDM 70 Shore A)</i></p>	<p><i>CIA 6245 (EPDM 70 Shore A)</i></p>	<p><i>CIA 6038 (EPDM 70 Shore A)</i> <i>CIA 15236 (TPE 70 Shore A)</i></p>
<p><i>CIA 6057 (EPDM 70 Shore A)</i></p>	<p><i>CIA 6037 (EPDM 70 Shore A)</i> <i>CIA 15235 (TPE 70 Shore A)</i></p>	<p><i>CIA 6096 (EPDM 70 Shore A)</i> <i>CIA 15237 (TPE 70 Shore A)</i></p>	<p><i>CIA 6036 (EPDM 70 Shore A)</i> <i>CIA 7079 (TPE 70 Shore A)</i></p>
<p><i>CIA 6444 (EPDM 70 Shore A)</i></p>	<p><i>CIA 6258 (EPDM 70 Shore A)</i></p>	<p><i>CIA 6460 (EPDM 80 Shore A)</i></p>	<p><i>CIA 6318 (EPDM 63 Shore A)</i></p>

PERFIL MACIÇO

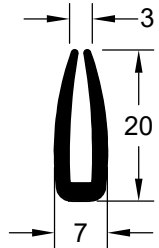
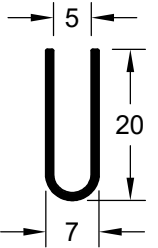
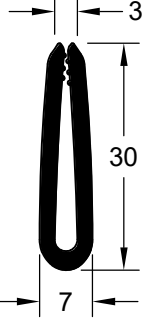
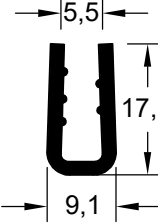
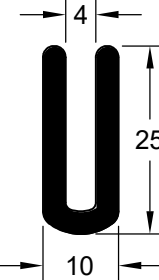
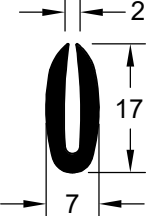
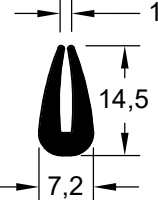
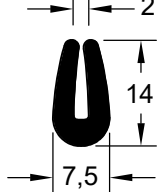
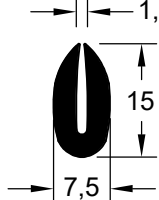
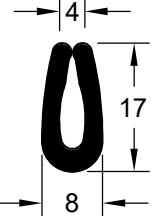
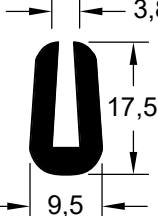
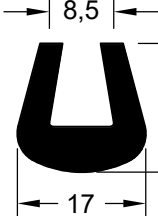
<p><i>CIA 6443 (EPDM 70 Shore A)</i></p> 	<p><i>CIA 6160 (EPDM 63 Shore A)</i></p> 	<p><i>CIA 6332 (EPDM 70 Shore A)</i></p> 	<p><i>CIA 16176 (EPDM 80 Shore A)</i></p> 
<p><i>CIA 6254 (EPDM 70 Shore A)</i></p> 	<p><i>CIA 6104 (EPDM 70 Shore A)</i></p> 	<p><i>CIA 6329 (EPDM 70 Shore A)</i></p> 	<p><i>CIA 6190 (EPDM 70 Shore A)</i></p> 
<p><i>CIA 6060 (EPDM 70 Shore A)</i> <i>CIA 15634 (TPE 70 Shore A)</i></p> 	<p><i>CIA 7010 (TPE 70 Shore A)</i></p> 	<p><i>CIA 19926 (EPDM 63 Shore A)</i></p> 	<p><i>CIA 6420 (NBR 70 Shore A)</i></p> 

PERFIL MACIÇO

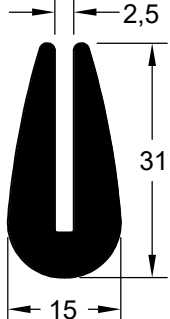
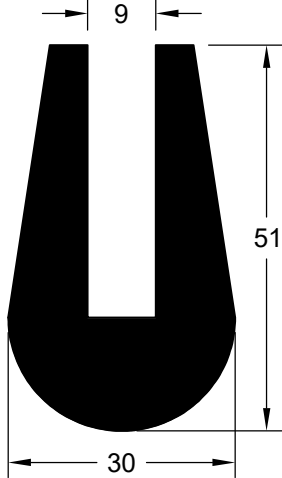
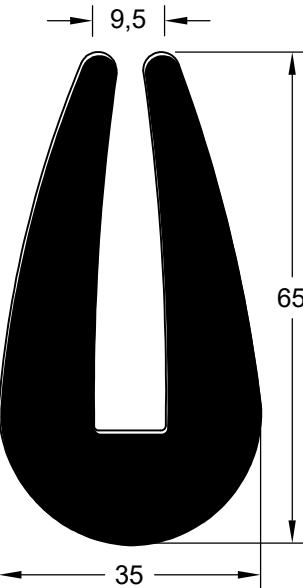
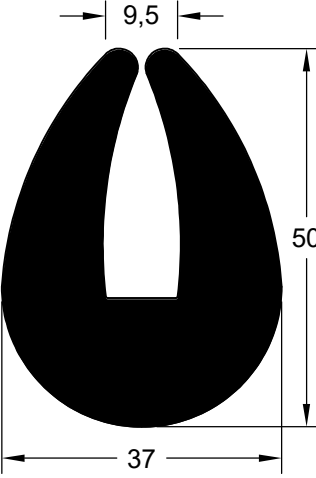
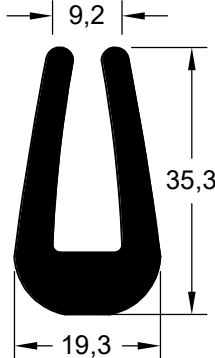
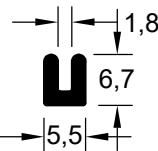
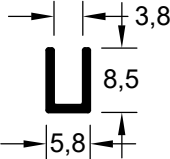
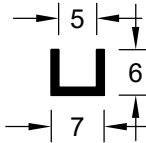
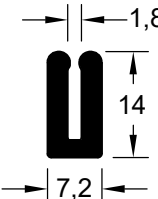
<p>CIA 6149 (EPDM 70 Shore A) CIA 16659 (TPE 70 Shore A)</p> 	<p>CIA 6441 (NBR 80 Shore A)</p> 	<p>CIA 6255 (EPDM 70 Shore A)</p> 	<p>CIA 6294 (EPDM 70 Shore A)</p> 
<p>CIA 16453 (EPDM 80 Shore A)</p> 	<p>CIA 6155 (EPDM 70 Shore A)</p> 	<p>CIA 6067 (EPDM 70 Shore A)</p> 	<p>CIA 16818 (EPDM 70 Shore A)</p> 
<p>CIA 6268 (EPDM 70 Shore A)</p> 			

PERFIL MACIÇO

<p>CIA 6039 (EPDM 70 Shore A)</p>	<p>CIA 6131 (EPDM 70 Shore A)</p>	<p>CIA 6452 (EPDM 70 Shore A)</p>	<p>CIA 6273 (EPDM 70 Shore A)</p>
<p>CIA 6267 (EPDM 80 Shore A)</p>	<p>CIA 7006 (TPE 70 Shore A)</p>	<p>CIA 6166 (EPDM 70 Shore A)</p>	<p>CIA 6040 (EPDM 70 Shore A) CIA 19331 (EPDM 80 Shore A)</p>
<p>CIA 6419 (EPDM 70 Shore A)</p>	<p>CIA 16298 (EPDM 70 Shore A)</p>	<p>CIA 16483 (EPDM 70 Shore A)</p>	

PERFIL MACIÇO

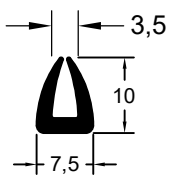
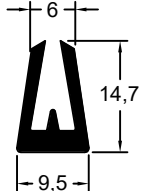
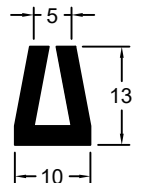
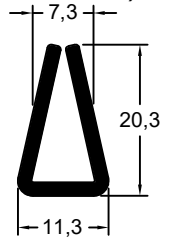
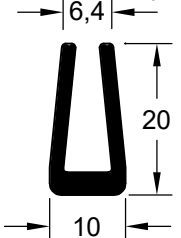
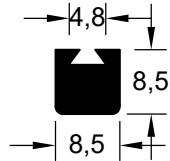
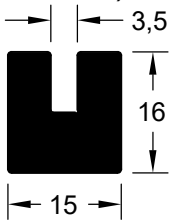
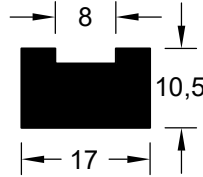
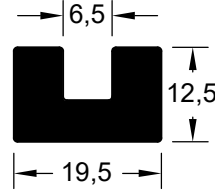
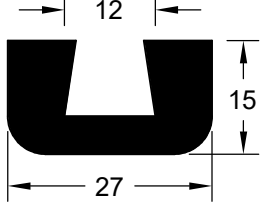
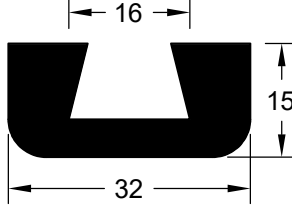
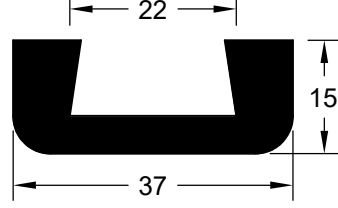
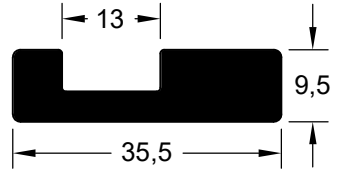
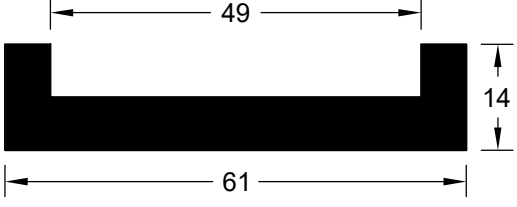
<p><i>CIA 6087 (EPDM 70 Shore A)</i></p> 	<p><i>CIA 6381 (EPDM 80 Shore A)</i></p> 	<p><i>CIA 18543 (NBR 60 Shore A)</i></p> 	<p><i>CIA 19033 (EPDM 80 Shore A)</i></p> 
<p><i>CIA 18918 (EPDM 70 Shore A)</i></p> 	<p><i>CIA 17145 (EPDM 70 Shore A)</i></p> 	<p><i>CIA 6066 (EPDM 70 Shore A)</i></p> 	<p><i>CIA 18816 (EPDM 70 Shore A)</i></p> 
<p><i>CIA 6393 (NBR 70 Shore A)</i></p> 	<p><i>CIA 16313 (NR 50 Shore A)</i></p> 	<p><i>CIA 16316 (NR 50 Shore A)</i></p> 	<p><i>CIA 16315 (NR 50 Shore A)</i></p> 
<p><i>CIA 6307 (EPDM 80 Shore A)</i></p> 	<p><i>CIA 6418 (SBR 70 Shore A)</i></p> 		

PERFIL MACIÇO

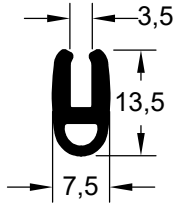
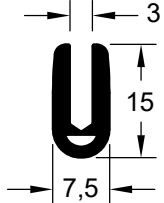
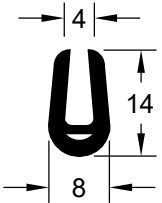
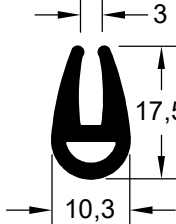
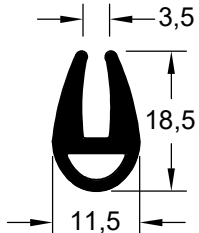
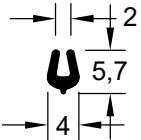
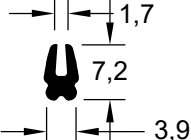
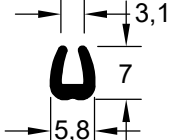
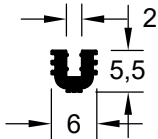
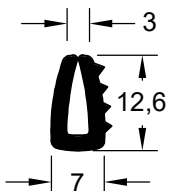
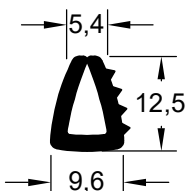
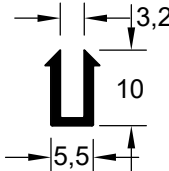
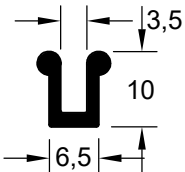
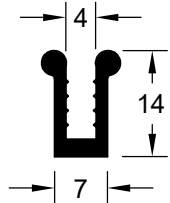
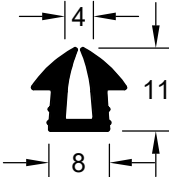
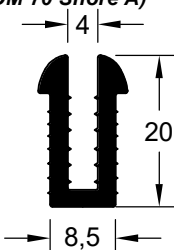
<p>CIA 7056 (TPE 70 Shore A)</p> 	<p>CIA 14837 (TPE 60 Shore A) CIA 15818 (TPE 70 Shore A)</p> 	<p>CIA 7076 (TPE 70 Shore A)</p> 	<p>CIA 6323 (EPDM 80 Shore A)</p> 
<p>CIA 6445 (NBR 70 Shore A)</p> 	<p>CIA 6167 (EPDM 70 Shore A)</p> 	<p>CIA 6169 (EPDM 70 Shore A)</p> 	<p>CIA 7049 (TPE 70 Shore A)</p> 
<p>CIA 6392 (EPDM 80 Shore A)</p> 	<p>CIA 6476 (EPDM 80 Shore A)</p> 	<p>CIA 6448 (EPDM 80 Shore A)</p> 	<p>CIA 6121 (EPDM 70 Shore A)</p> 
<p>CIA 6041 (EPDM 70 Shore A)</p> 	<p>CIA 16805 (EPDM 70 Shore A)</p> 	<p>CIA 6372 (EPDM 80 Shore A)</p> 	<p>CIA 6126 (EPDM 70 Shore A)</p> 

PERFIL MACIÇO

<p>CIA 6116 (SBR 70 Shore A)</p>	<p>CIA 14120 (EPDM 80 Shore A)</p>	<p>CIA 6034 (EPDM 70 Shore A)</p>	<p>CIA 6118 (EPDM 80 Shore A)</p>
<p>CIA 6396 (EPDM 80 Shore A)</p>	<p>CIA 14029 (EPDM 70 Shore A)</p>	<p>CIA 6403 (EPDM 63 Shore A)</p>	<p>CIA 6120 (EPDM 80 Shore A)</p>
<p>CIA 15781 (EPDM 80 Shore A)</p>	<p>CIA 6390 (EPDM 63 Shore A)</p>	<p>CIA 9058 (EPDM 63 Shore A)</p>	<p>CIA 19944 (EPDM 63 Shore A)</p>
<p>CIA 6455 (EPDM 70 Shore A)</p>			

PERFIL MACIÇO

<p>CIA 6226 (EPDM 63 Shore A)</p>	<p>CIA 7081 (TPE 60 Shore A)</p>	<p>CIA 7082 (TPE 60 Shore A)</p>	<p>CIA 14937 (TPE 60 Shore A)</p>
<p>CIA 14625 (EPDM 63 Shore A)</p>	<p>CIA 18688 (EPDM 63 Shore A)</p>	<p>CIA 18686 (EPDM 63 Shore A)</p>	<p>CIA 18678 (EPDM 60 Shore A)</p>
<p>CIA 16311 (EPDM 60 Shore A)</p>	<p>CIA 17314 (EPDM 63 Shore A)</p>	<p>CIA 6436 (SBR 60 Shore A)</p>	<p>CIA 6354 (EPDM 80 Shore A)</p>
<p>CIA 6093 (EPDM 63 Shore A)</p>	<p>CIA 16754 (EPDM 70 Shore A)</p>	<p>CIA 6357 (EPDM 80 Shore A)</p>	<p>CIA 18755 (EPDM 70 Shore A)</p>



PERFIL MACIÇO

<p><i>CIA 18452 (NBR 80 Shore A)</i></p> <p>40,7 33</p>	<p><i>CIA 6387 (SBR 80 Shore A)</i></p> <p>41,5 28,5</p>	<p><i>CIA 6386 (SBR 80 Shore A)</i></p> <p>41 30</p>	<p><i>CIA 17011 (EPDM 80 Shore A)</i></p> <p>42,6 42,5</p>
<p><i>CIA 6415 (EPDM 80 Shore A)</i></p> <p>20 4 20</p>	<p><i>CIA 6414 (EPDM 80 Shore A)</i></p> <p>30 5 30</p>	<p><i>CIA 6222 (EPDM 70 Shore A)</i></p> <p>22 40</p>	
<p><i>CIA 19351 (EPDM 80 Shore A)</i></p> <p>24,5 39,5</p>	<p><i>CIA 15703 (EPDM 70 Shore A)</i></p> <p>24 39</p>	<p><i>CIA 17362 (EPDM 80 Shore A)</i></p> <p>33 40 23</p>	<p><i>CIA 6367 (CR 70 Shore A)</i></p> <p>26,5 48,5 18</p>
<p><i>CIA 15750 (EPDM 70 Shore A)</i></p> <p>12,8 18,3 19,8</p>			

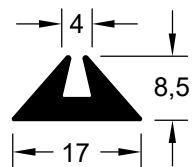
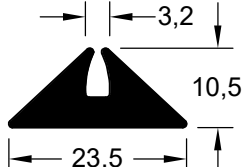
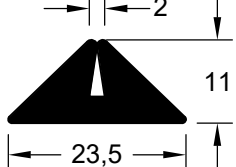
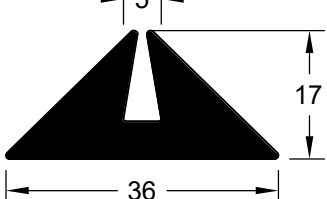
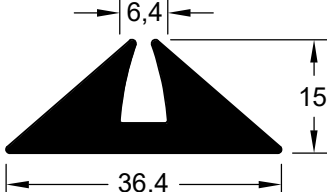
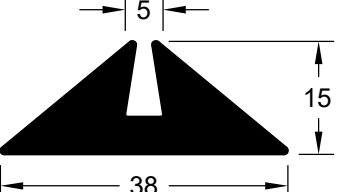
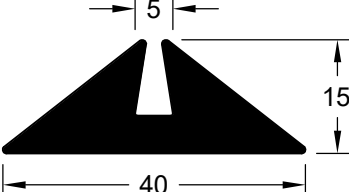
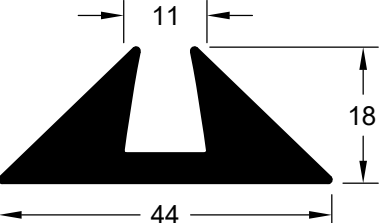
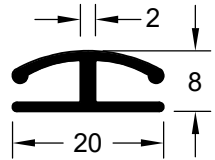
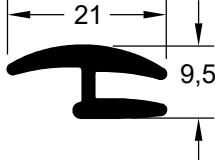
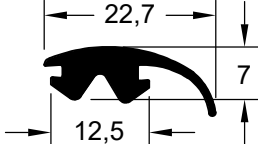
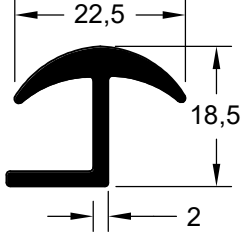
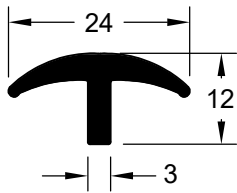
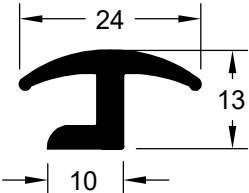
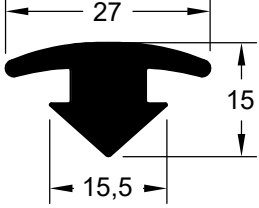
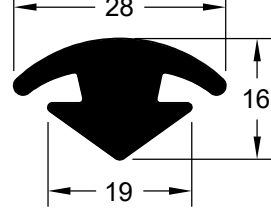
PERFIL MACIÇO

<p>CIA 17217 (NBR 80 Shore A)</p> 	<p>CIA 16778 (NBR 80 Shore A)</p> 	<p>CIA 18575 (NBR 80 Shore A)</p> 	<p>CIA 17592 (NBR 80 Shore A)</p> 
<p>CIA 16779 (NBR 80 Shore A)</p> 	<p>CIA 17590 (NBR 80 Shore A)</p> 	<p>CIA 17591 (NBR 80 Shore A)</p> 	<p>CIA 16892 (NBR 80 Shore A)</p> 
<p>CIA 7060 (TPE 70 Shore A)</p> 	<p>CIA 18081 (TPE 70 Shore A)</p> 	<p>CIA 7061 (TPE 70 Shore A)</p> 	<p>CIA 6069 (EPDM 70 Shore A)</p> 
<p>CIA 6214 (EPDM 80 Shore A)</p> 	<p>CIA 6215 (EPDM 80 Shore A)</p> 	<p>CIA 6230 (EPDM 80 Shore A)</p> 	<p>CIA 7025 (TPE 70 Shore A)</p> 

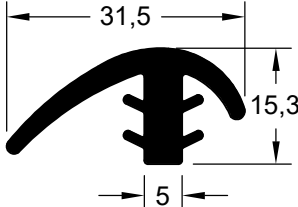
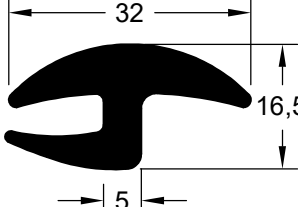
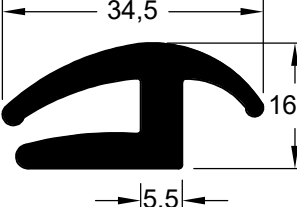
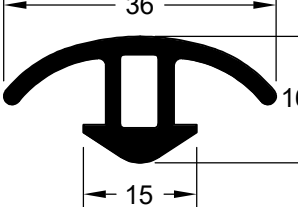
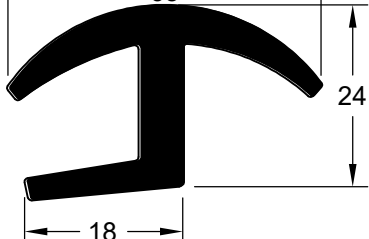
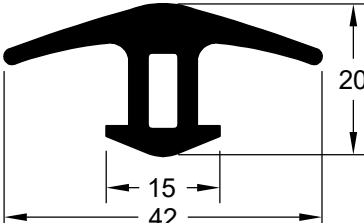
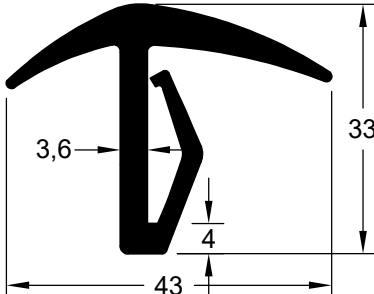
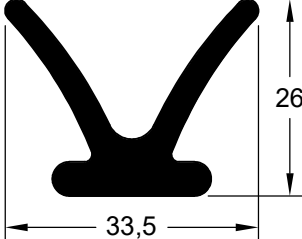
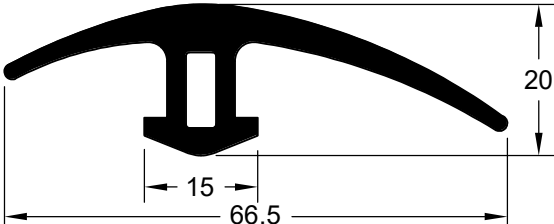
PERFIL MACIÇO

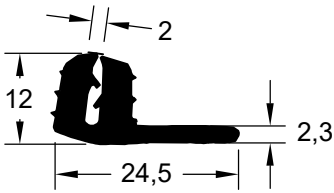
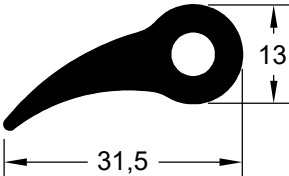
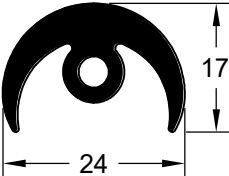
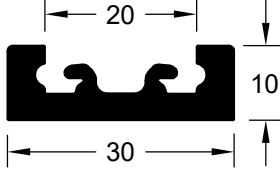
<p>CIA 6342 (EPDM 80 Shore A)</p> 	<p>CIA 6427 (EPDM 63 Shore A)</p> 	<p>CIA 6110 (EPDM 80 Shore A)</p> 	<p>CIA 18569 (PVC 85 Shore A)</p> 
<p>CIA 6408 (EPDM 80 Shore A)</p> 	<p>CIA 6359 (EPDM 80 Shore A) CIA 7072 (TPE 70 Shore A)</p> 	<p>CIA 16083 (EPDM 70 Shore A)</p> 	<p>CIA 17854 (EPDM 70 Shore A)</p> 
<p>CIA 6478 (EPDM 80 Shore A)</p> 		<p>CIA 19925 (EPDM 80 Shore A)</p> 	
<p>CIA 17846 (TPE 60 Shore A)</p> 	<p>CIA 6463 (EPDM 70 Shore A)</p> 	<p>CIA 6094 (EPDM 80 Shore A)</p> 	<p>CIA 6507 (EPDM 80 Shore A)</p> 

PERFIL MACIÇO

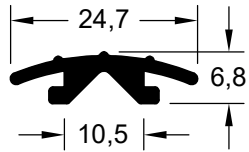
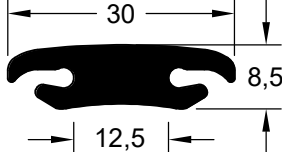
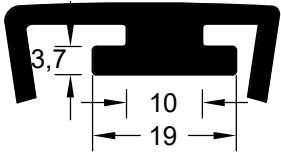
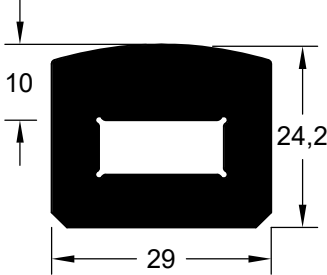
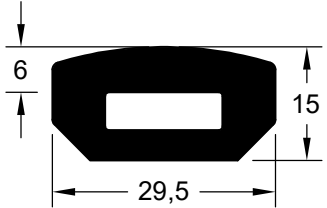
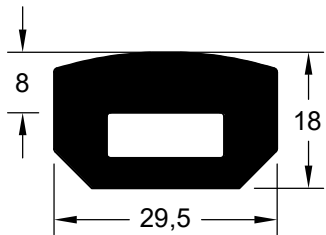
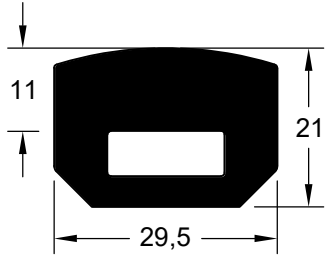
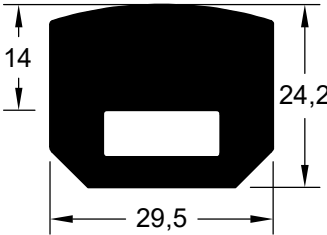
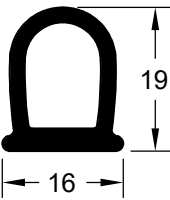
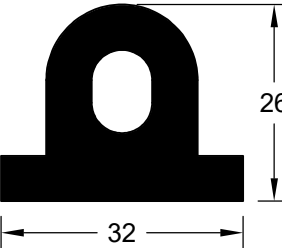
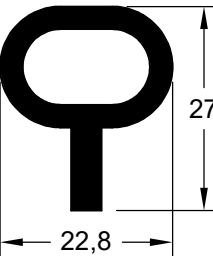
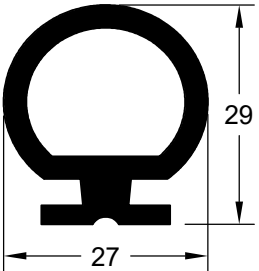
<p><i>CIA 17419 (EPDM 80 Shore A)</i></p> 	<p><i>CIA 16810 (EPDM 70 Shore A)</i></p> 	<p><i>CIA 15827 (EPDM 70 Shore A)</i></p> 	<p><i>CIA 17491 (CR 80 Shore A)</i></p> 
<p><i>CIA 16509 (CR 80 Shore A)</i></p> 	<p><i>CIA 16510 (CR 80 Shore A)</i></p> 	<p><i>CIA 17124 (CR 80 Shore A)</i></p> 	<p><i>CIA 17125 (CR 80 Shore A)</i></p> 
<p><i>CIA 18690 (EPDM 55 Shore A)</i></p> 	<p><i>CIA 18311 (EPDM 55 Shore A)</i></p> 	<p><i>CIA 18925 (NBR 70 Shore A)</i></p> 	<p><i>CIA 17913 (EPDM 70 Shore A)</i></p> 

PERFIL MACIÇO

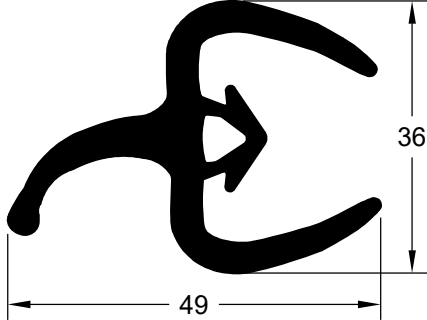
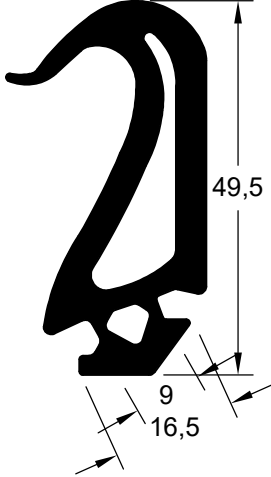
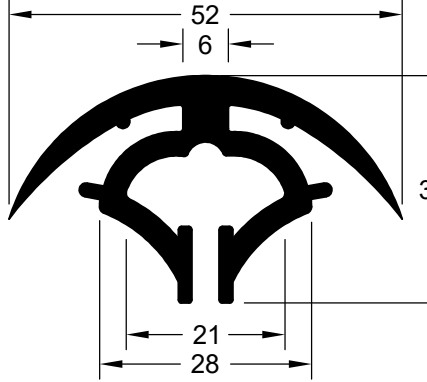
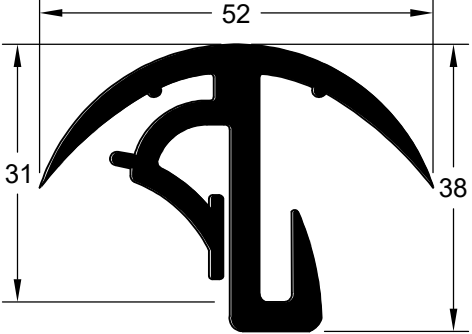
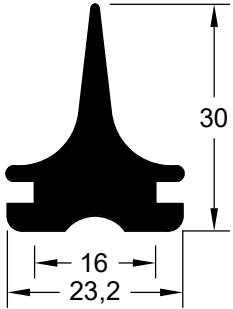
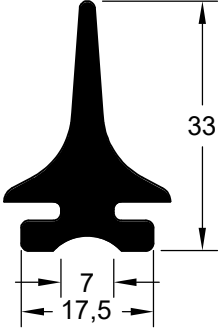
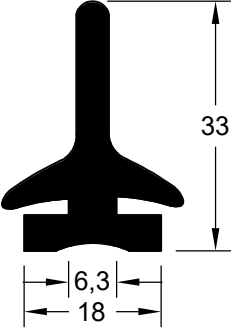
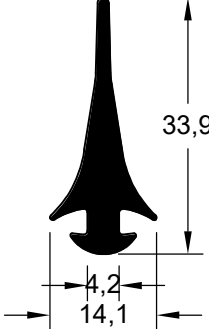
<p><i>CIA 20023 (EPDM 70 Shore A)</i></p> 	<p><i>CIA 6099 (SBR 70 Shore A)</i></p> 	<p><i>CIA 6435 (EPDM 80 Shore A)</i></p> 	<p><i>CIA 6498 (EPDM 80 Shore A)</i></p> 
<p><i>CIA 6481 (EPDM 63 Shore A)</i></p> 	<p><i>CIA 19433 (TPE 70 Shore A)</i></p> 	<p><i>CIA 6088 (EPDM 70 Shore A)</i></p> 	<p><i>CIA 16823 (EPDM 70 Shore A)</i></p> 

PERFIL MACIÇO

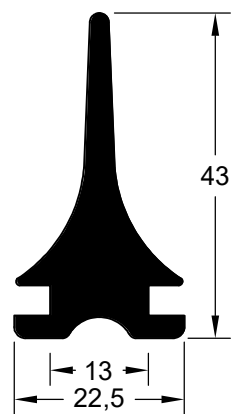
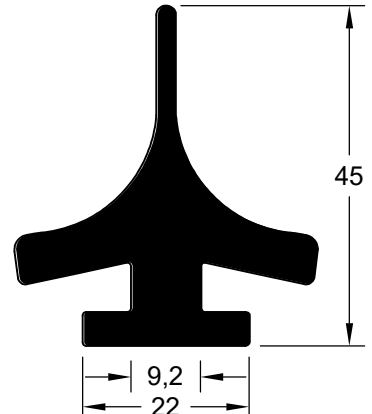
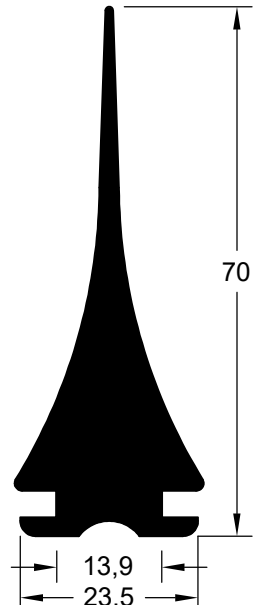
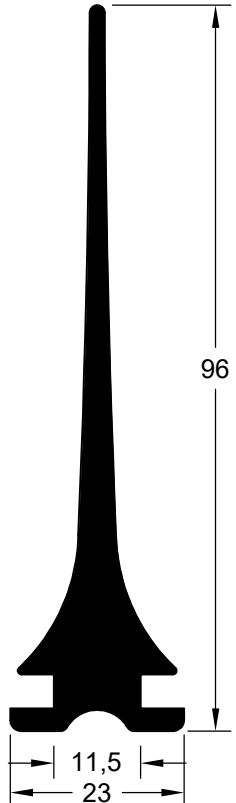
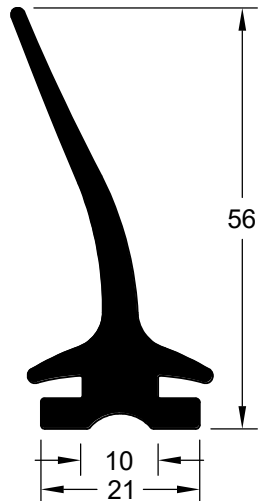
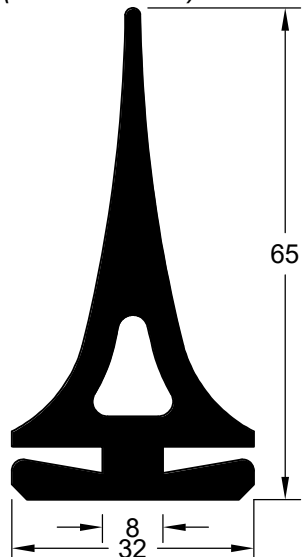
<p><i>CIA 7021 (TPE 70 Shore A)</i></p> 	<p><i>CIA 17400 (EPDM 70 Shore A)</i></p> 	<p><i>CIA 7073 (TPE 60 Shore A)</i></p> 	<p><i>CIA 7022 (TPE 70 Shore A)</i></p> 
<p><i>CIA 6407 (EPDM 70 Shore A)</i></p> 	<p><i>CIA 9117 (EPDM 80 Shore A)</i></p> 		

PERFIL MACIÇO

CIA 15404 (TPE 70 Shore A)

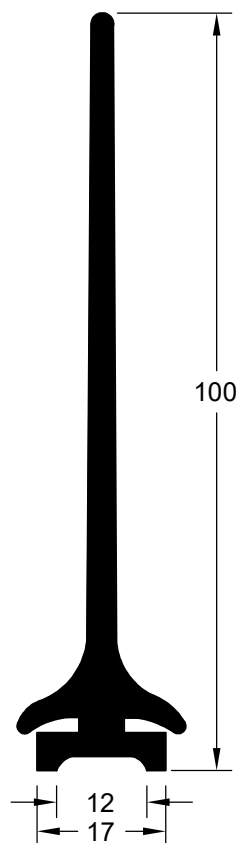

CIA 6233 (EPDM 63 Shore A)

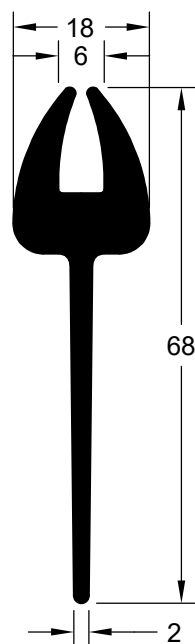

CIA 6380 (EPDM 70 Shore A)

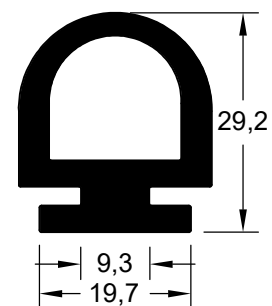

CIA 6247 (SBR 70 Shore A)

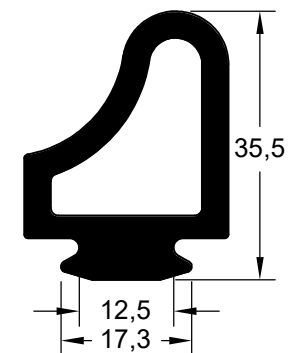

CIA 9124 (EPDM 70 Shore A)

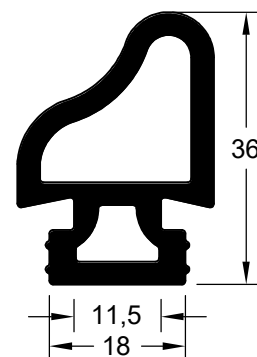

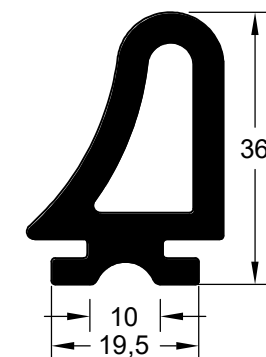

CIA 6328 (EPDM 70 Shore A)

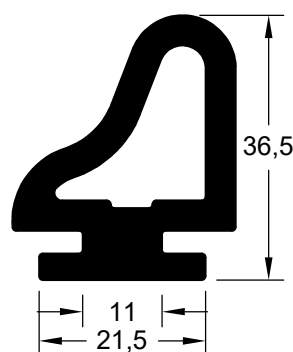
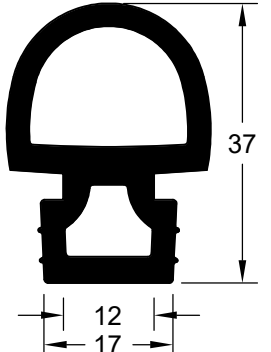
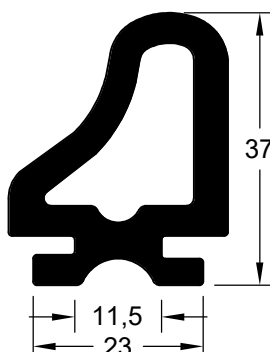
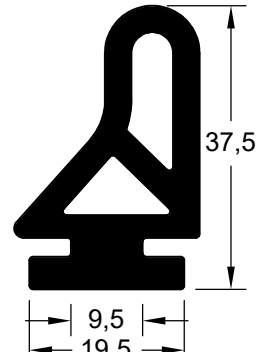
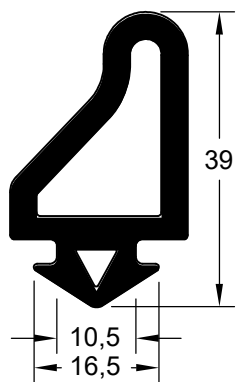
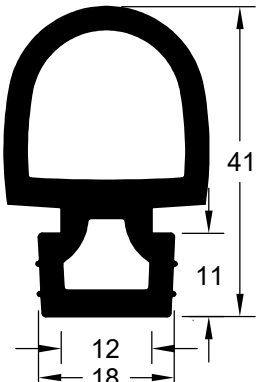
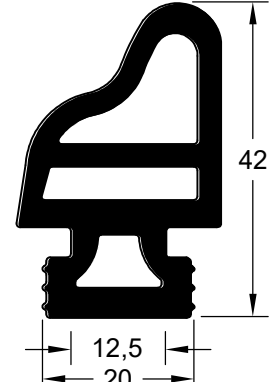
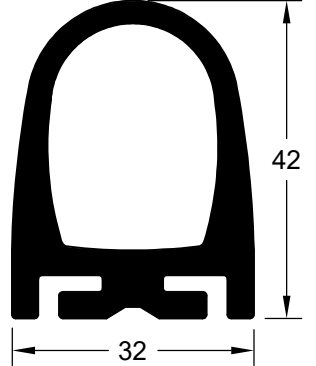

PERFIL MACIÇO

<p><i>CIA 6312 (EPDM 70 Shore A)</i></p> 	<p><i>CIA 18972 (EPDM 70 Shore A)</i></p> 	<p><i>CIA 6163 (EPDM 70 Shore A)</i></p> 	<p><i>CIA 6346 (EPDM 70 Shore A)</i></p> 
<p><i>CIA 6059 (SBR 70 Shore A)</i></p> 	<p><i>CIA 6500 (EPDM 70 Shore A)</i></p> 	<p><i>CIA 6219 (EPDM 63 Shore A)</i></p> 	<p><i>CIA 18645 (EPDM 63 Shore A)</i></p> 

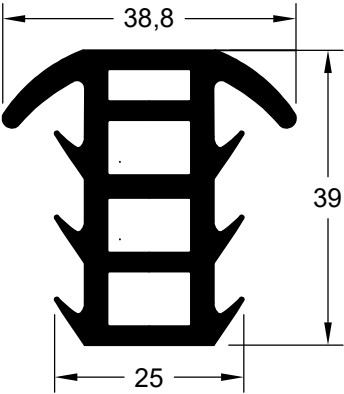
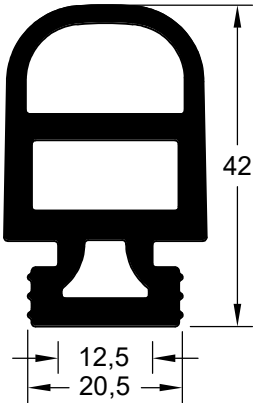
PERFIL MACIÇO

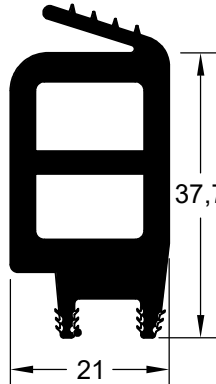
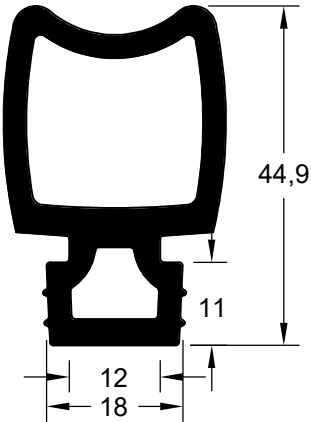
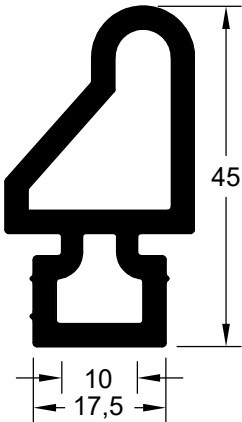
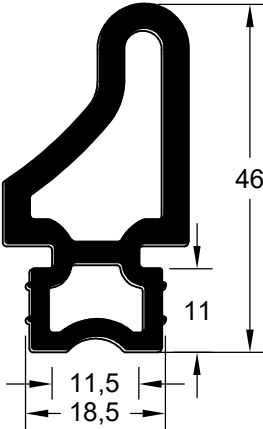
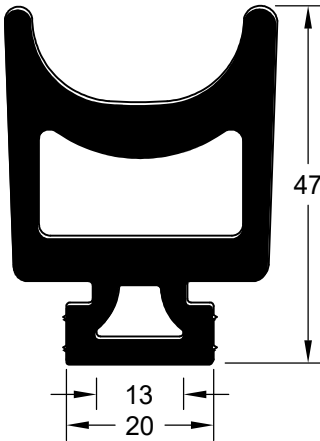
<p><i>CIA 18834 (EPDM 70 Shore A)</i></p> 	<p><i>CIA 6421 (EPDM 80 Shore A)</i></p> 	<p><i>CIA 18375 (EPDM 55 Shore A)</i></p> 	<p><i>CIA 17903 (EPDM 63 Shore A)</i></p> 
<p><i>CIA 16496 (EPDM 70 Shore A)</i></p> 	<p><i>CIA 14943 (EPDM 80 Shore A)</i></p> 	<p><i>CIA 6362 (EPDM 70 Shore A)</i></p> 	<p><i>CIA 15075 (EPDM 70 Shore A)</i></p> 

PERFIL MACIÇO

<p><i>CIA 18984 (EPDM 70 Shore A)</i></p> <p>47 27,3</p>	<p><i>CIA 6092 (EPDM 63 Shore A)</i></p> <p>47,5 12 21</p>	<p><i>CIA 6411 (EPDM 80 Shore A)</i></p> <p>42,5 49 12,5 20,5</p>	<p><i>CIA 9132 (EPDM 70 Shore A)</i></p> <p>51 12 18</p>
<p><i>CIA 6208 (EPDM 70 Shore A)</i></p> <p>51 12,5 19,5</p>	<p><i>CIA 15825 (EPDM 70 Shore A)</i></p> <p>52 10 19</p>	<p><i>CIA 15826 (EPDM 70 Shore A)</i></p> <p>52 10 19</p>	<p><i>CIA 19547 (EPDM 70 Shore A)</i></p> <p>52 10 19</p>

PERFIL MACIÇO

<p><i>CIA 19548 (EPDM 70 Shore A)</i></p>	<p><i>CIA 6451 (EPDM 63 Shore A)</i></p>	<p><i>CIA 6122 (EPDM 70 Shore A)</i></p>	<p><i>CIA 6077 (EPDM 70 Shore A)</i></p>
<p><i>CIA 19885 (EPDM 80 Shore A)</i></p>	<p><i>CIA 6284 (EPDM 70 Shore A)</i></p>		

CIA 6285 (EPDM 70 Shore A)

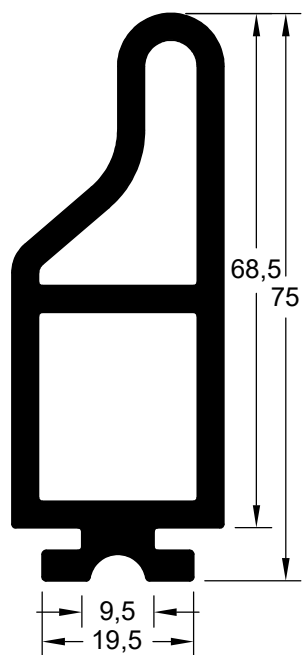

CIA 6446 (EPDM 70 Shore A)

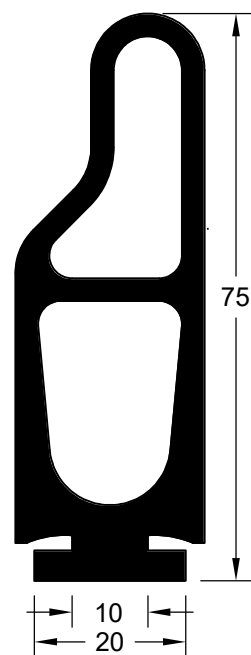

CIA 16031 (EPDM 70 Shore A)

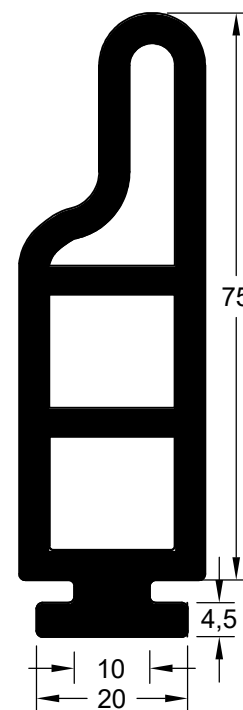

CIA 6165 (EPDM 70 Shore A)

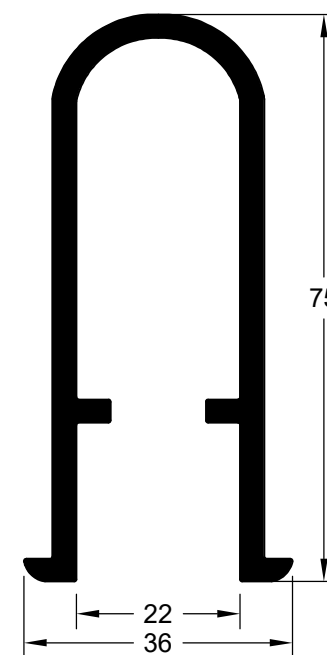

PERFIL MACIÇO

CIA 6487 (EPDM 70 Shore A)

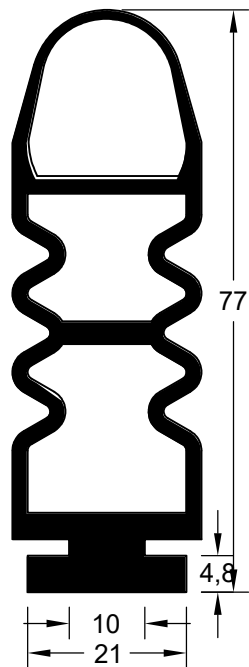

CIA 6363 (EPDM 70 Shore A)

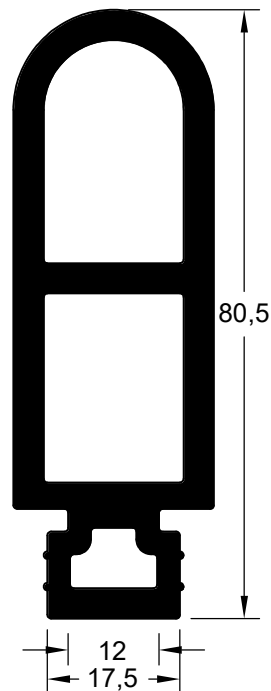

CIA 6213 (EPDM 63 Shore A)

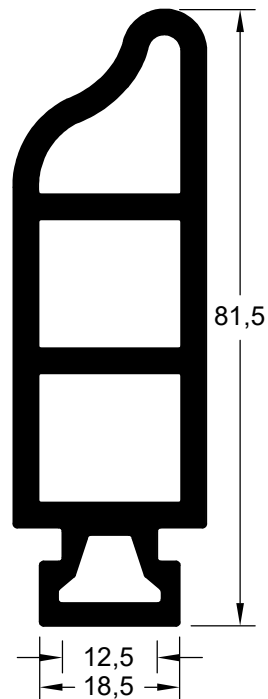

CIA 6491 (EPDM 63 Shore A)

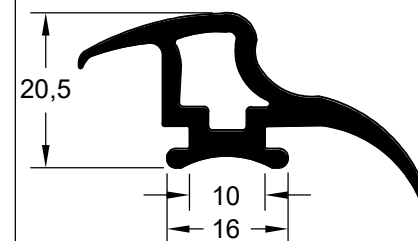

CIA 15127 (TPE 60 Shore A)

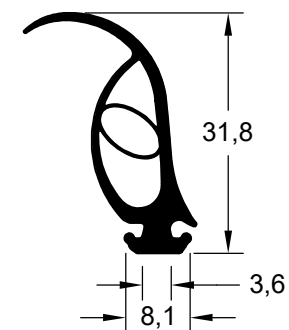

PERFIL MACIÇO

<p><i>CIA 14252 (TPE 60 Shore A)</i></p>	<p><i>CIA 6360 (EPDM 80 Shore A)</i></p>	<p><i>CIA 17198 (EPDM 70 Shore A)</i></p>
<p><i>CIA 6437 (EPDM 80 Shore A)</i></p>	<p><i>CIA 6438 (EPDM 80 Shore A)</i></p>	<p><i>CIA 6422 (EPDM 80 Shore A)</i></p>
<p><i>CIA 9156 (EPDM 80 Shore A)</i></p>	<p><i>CIA 19888 (EPDM 80 Shore A)</i></p>	<p><i>CIA 6437 (EPDM 80 Shore A)</i></p>

PERFIL MACIÇO

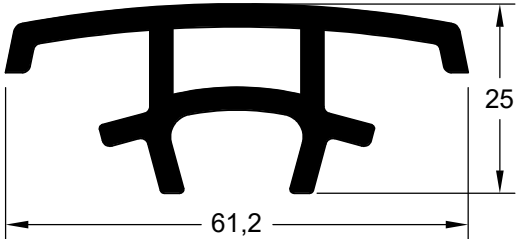
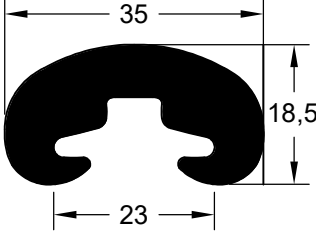
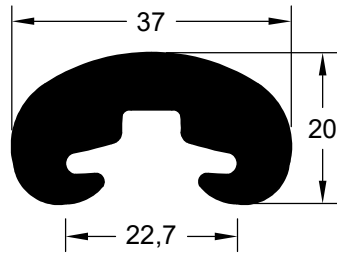
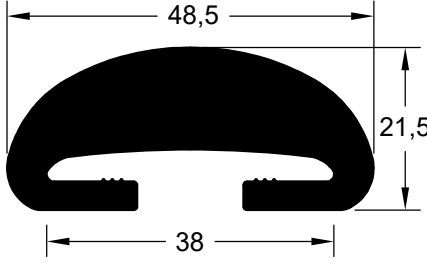
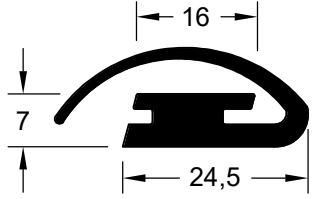
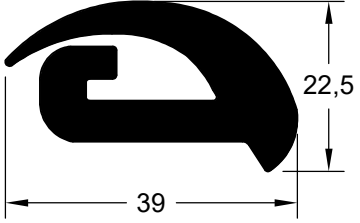
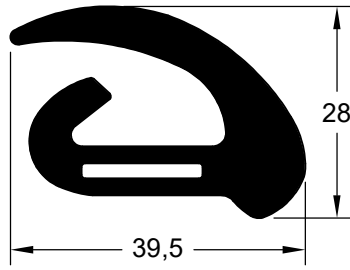
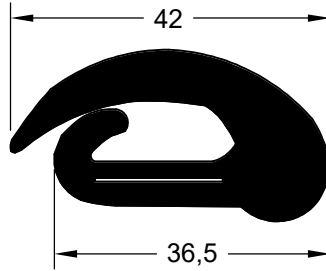
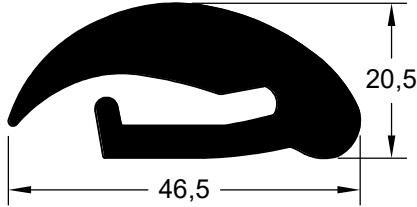
<p><i>CIA 18143 (EPDM 63 Shore A)</i></p> 	<p><i>CIA 6050 (EPDM 80 Shore A)</i></p> 	<p><i>CIA 6100 (EPDM 80 Shore A)</i></p> 
<p><i>CIA 6287 (EPDM 80 Shore A)</i></p> 	<p><i>CIA 6256 (EPDM 80 Shore A)</i></p> 	<p><i>CIA 6091 (EPDM 80 Shore A)</i></p> 
<p><i>CIA 6345 (EPDM 70 Shore A)</i></p> 	<p><i>CIA 19606 (EPDM 70 Shore A)</i></p> 	<p><i>CIA 6051 (EPDM 80 Shore A)</i></p> 

PERFIL MACIÇO

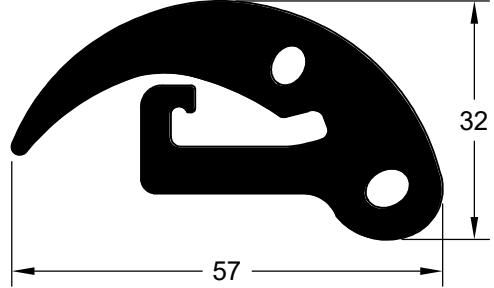
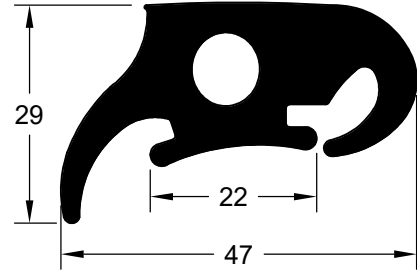
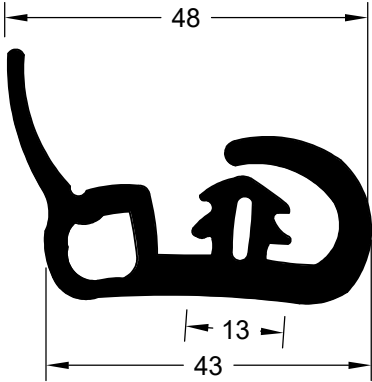
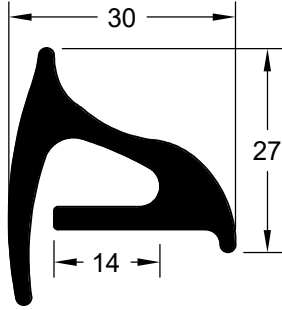
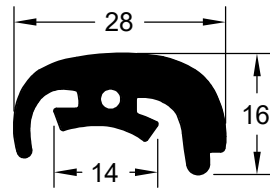
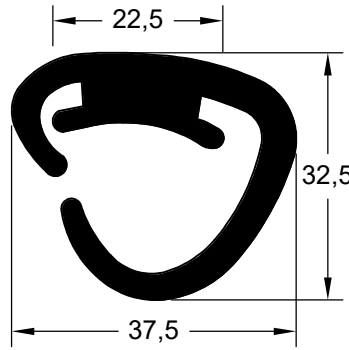
<p><i>CIA 6493 (EPDM 70 Shore A)</i></p> 	<p><i>CIA 6090 (EPDM 80 Shore A)</i></p> 	<p><i>CIA 6192 (EPDM 63 Shore A)</i></p> 	
<p><i>CIA 14065 (EPDM 70 Shore A)</i></p> 	<p><i>CIA 6483 (EPDM 80 Shore A)</i></p> 	<p><i>CIA 6221 (EPDM 80 Shore A)</i></p> 	<p><i>CIA 6196 (EPDM 80 Shore A)</i></p> 

PERFIL MACIÇO

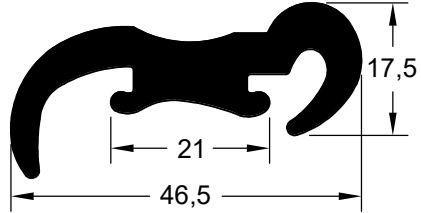
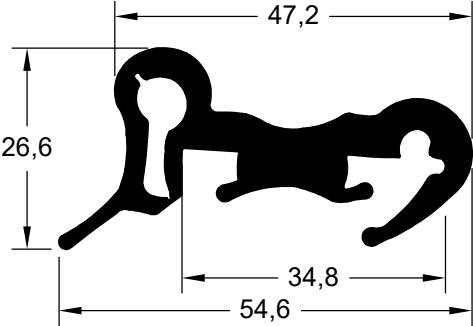
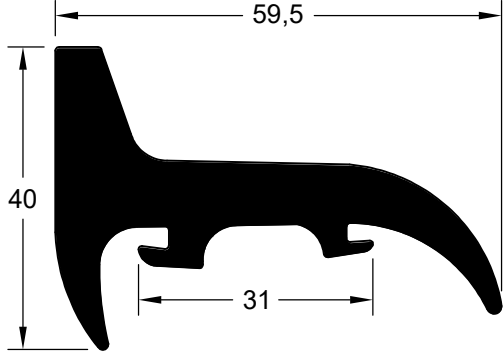
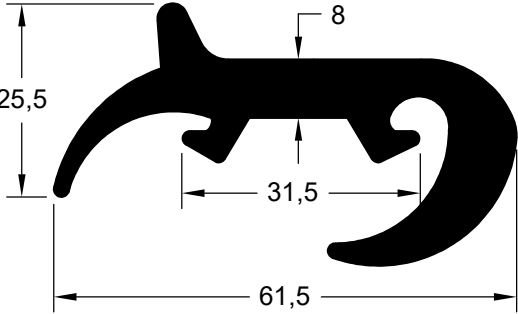
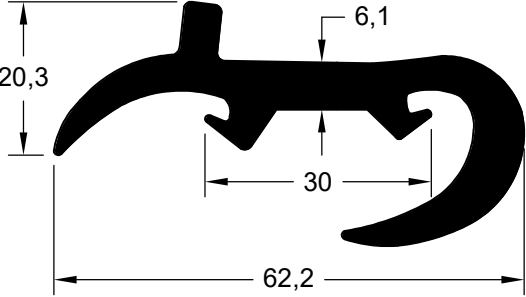
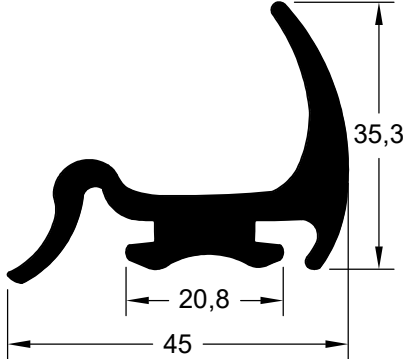
<p><i>CIA 6108 (EPDM 80 Shore A)</i></p> 	<p><i>CIA 17527 (EPDM 70 Shore A)</i></p> 	<p><i>CIA 9116 (EPDM 80 Shore A)</i></p> 
<p><i>CIA 9118 (EPDM 80 Shore A)</i></p> 	<p><i>CIA 17311 (EPDM 80 Shore A)</i></p> 	<p><i>CIA 6397 (EPDM 80 Shore A)</i></p> 

PERFIL MACIÇO

CIA 6210 (EPDM 80 Shore A)

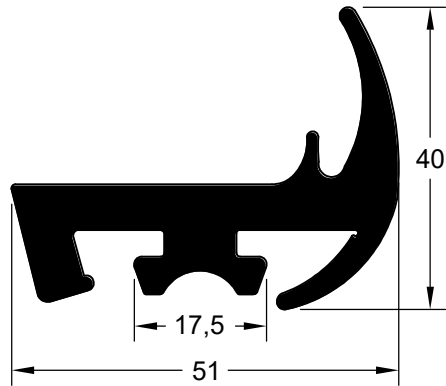

CIA 6488 (EPDM 80 Shore A)

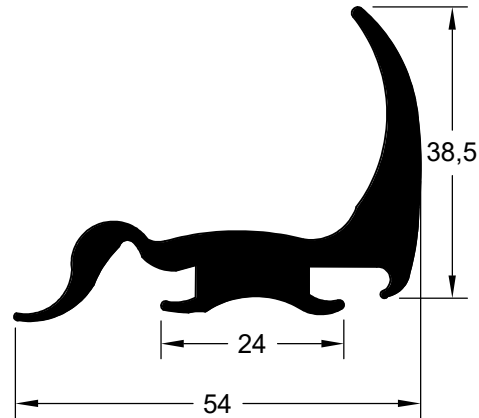

CIA 9134 (EPDM 70 Shore A)

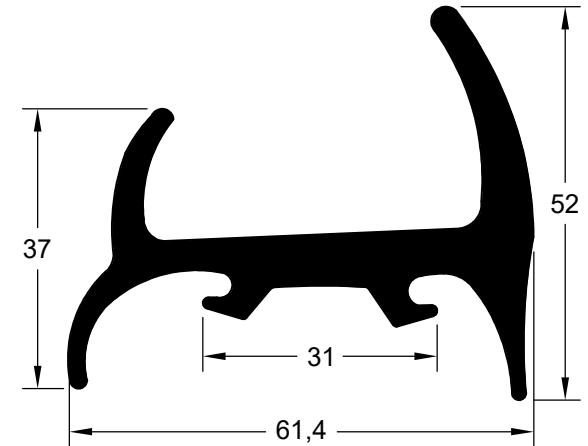

CIA 7029 (TPE 70 Shore A)

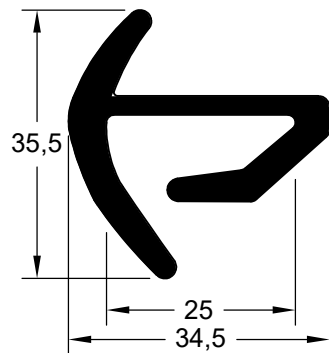

CIA 6340 (EPDM 80 Shore A)

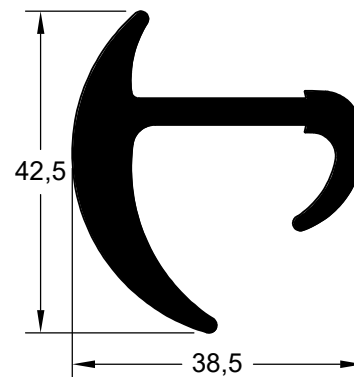

CIA 6339 (EPDM 80 Shore A)

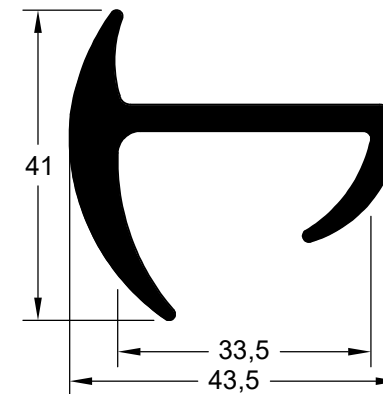

PERFIL MACIÇO

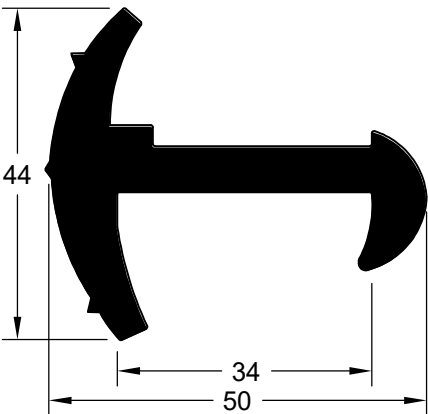
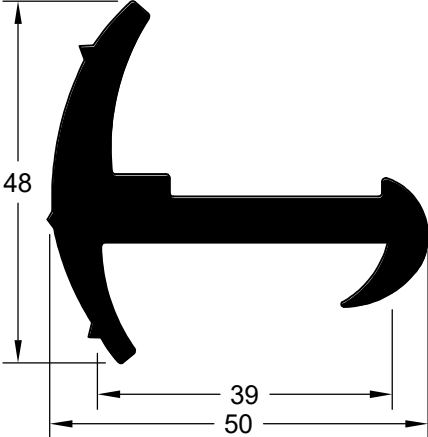
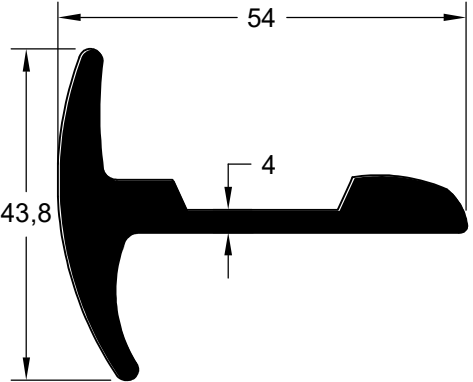
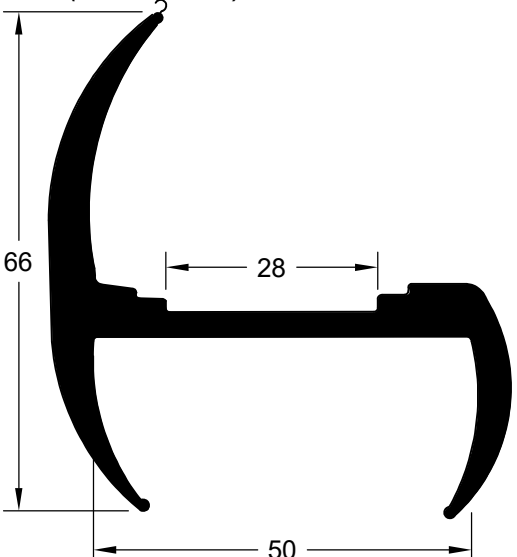
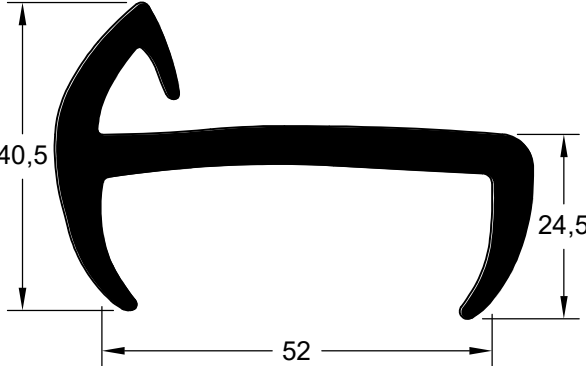
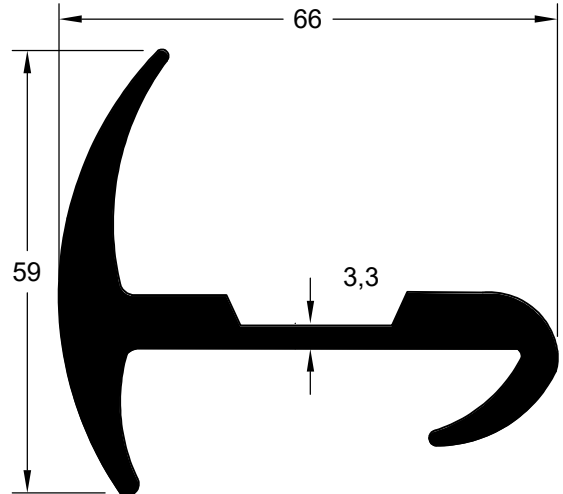
<p><i>CIA 6031 (EPDM 70 Shore A)</i></p>  <p>44 34 50</p>	<p><i>CIA 6239 (EPDM 70 Shore A)</i></p>  <p>48 39 50</p>	<p><i>CIA 18993 (EPDM 70 Shore A)</i></p>  <p>54 43,8 4</p>
<p><i>CIA 6369 (TPE 65 Shore A)</i></p>  <p>66 28 50</p>	<p><i>CIA 16633 (TPE 85 Shore A)</i></p>  <p>40,5 52 24,5</p>	<p><i>CIA 19237 (EPDM 80 Shore A)</i></p>  <p>66 59 3,3</p>

PERFIL MACIÇO

CIA 6203 (EPDM 80 Shore A)

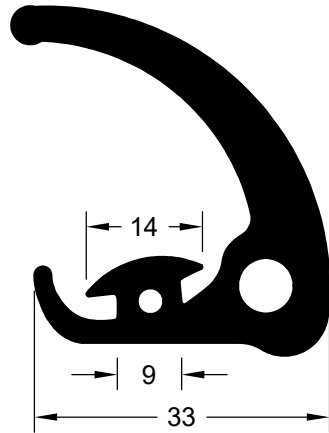

CIA 9154 (EPDM 70 Shore A)

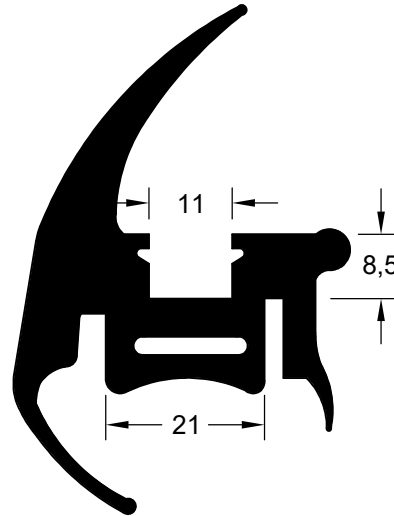

CIA 20018 (EPDM 70 Shore A)

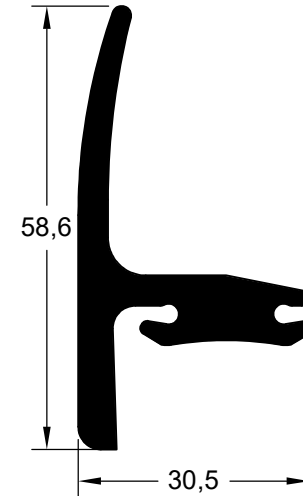

CIA 9144 (EPDM 70 Shore A)

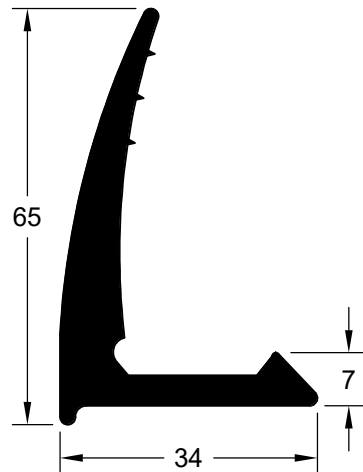

CIA 15073 (EPDM 70 Shore A)

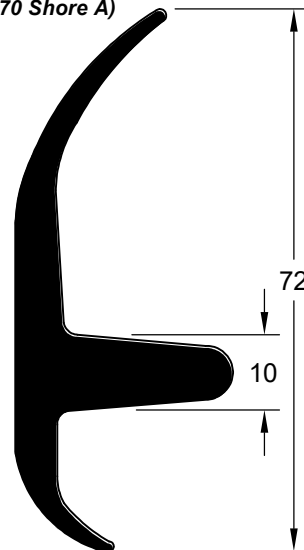

CIA 18017 (EPDM 80 Shore A)



PERFIL MACIÇO

CIA 16742 (TPE 70 Shore A)

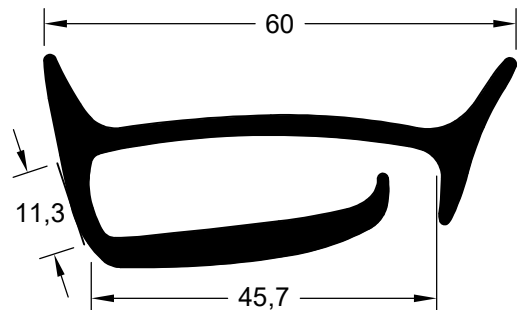

CIA 18457 (EPDM 80 Shore A)

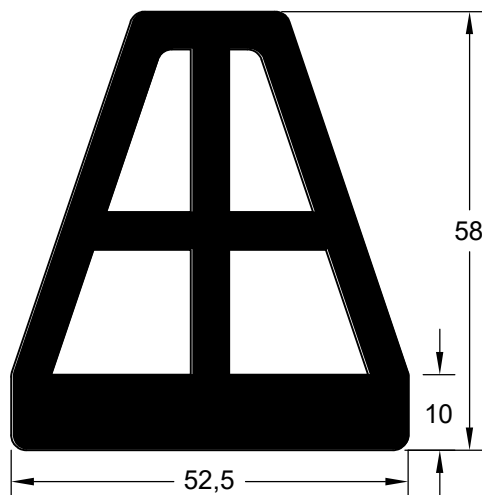

CIA 14842 (EPDM 70 Shore A)

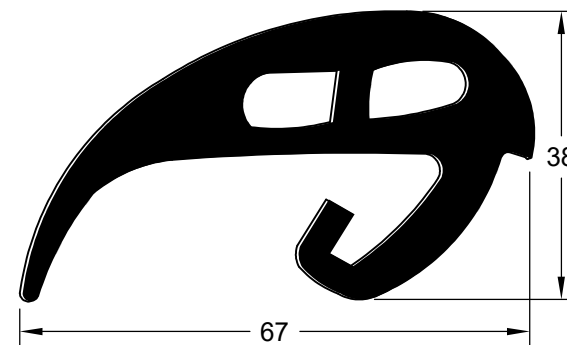

CIA 17489 (EPDM 70 Shore A)

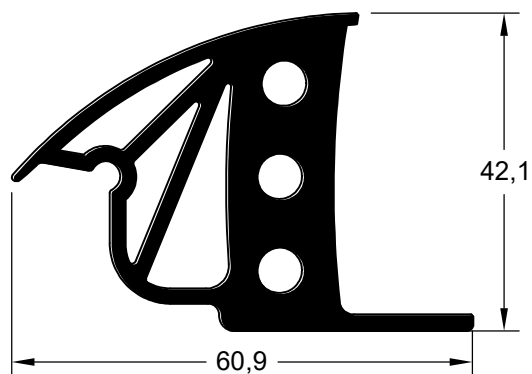

CIA 6341 (EPDM 80 Shore A)

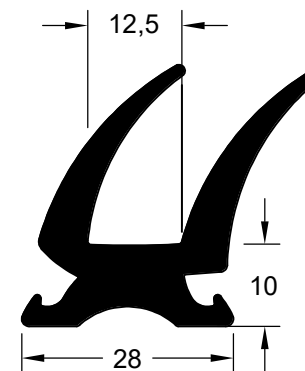

CIA 16643 (EPDM 80 Shore A)

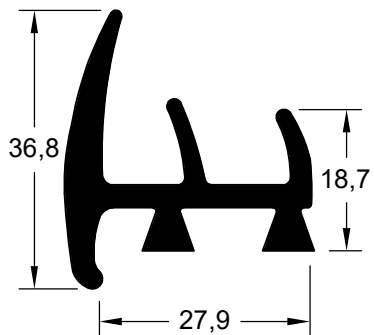

CIA 6177 (EPDM 80 Shore A)

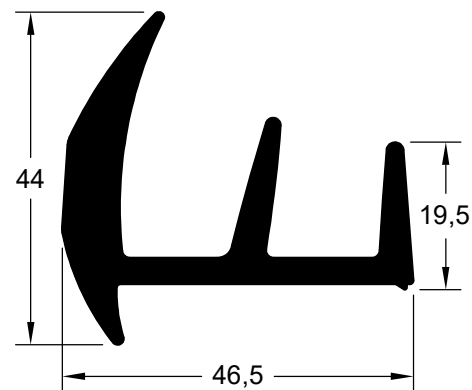

CIA 19527 (EPDM 75 Shore A)

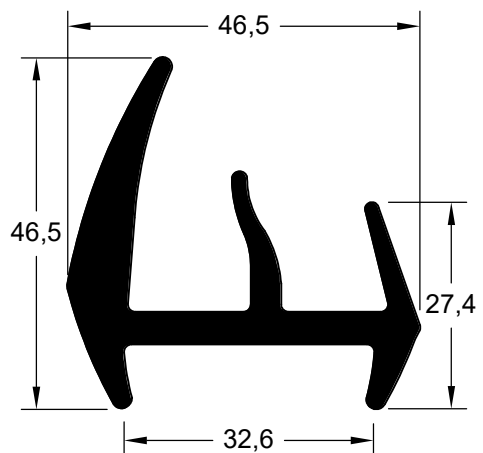

CIA 17521 (EPDM 75 Shore A)

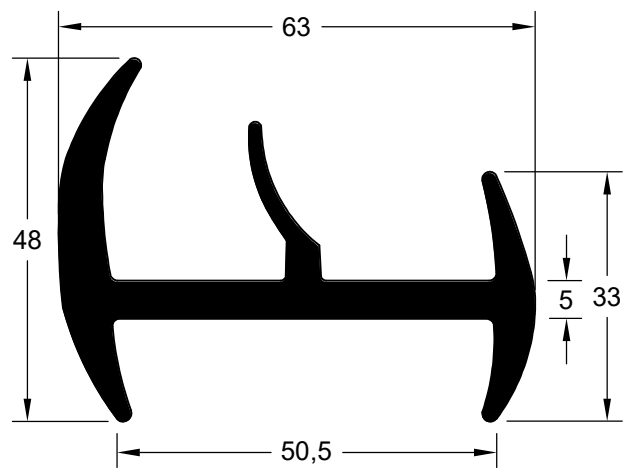

CIA 6162 (EPDM 80 Shore A)

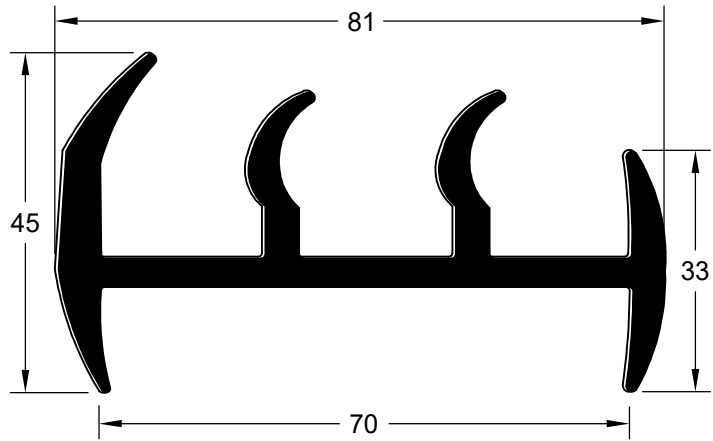

CIA 18479 (EPDM 75 Shore A)

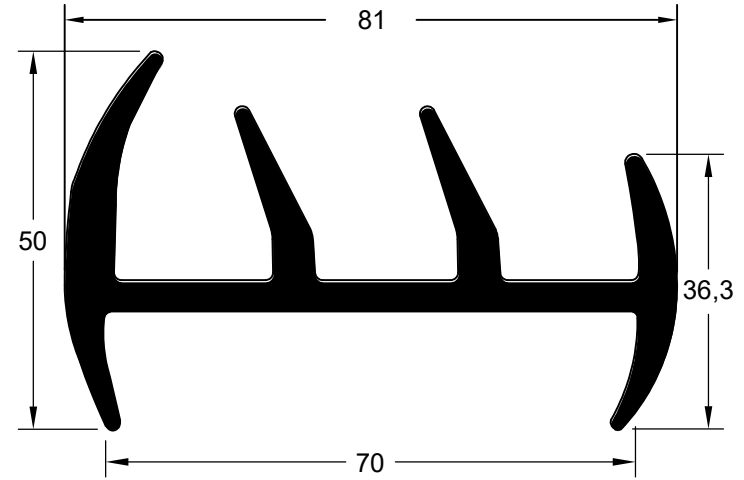

CIA 19879 (EPDM 75 Shore A)

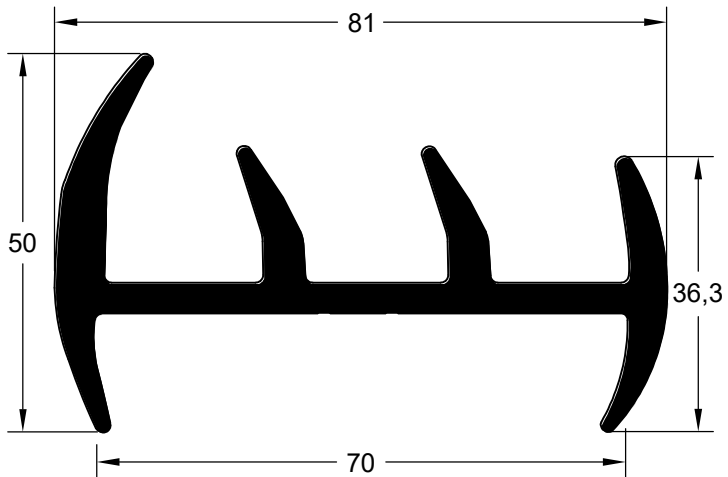

CIA 16857 (EPDM 75 Shore A)

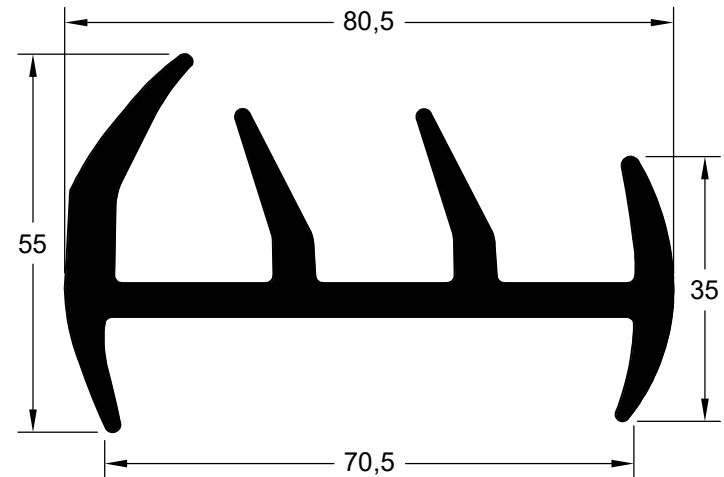

CIA 6046 (EPDM 70 Shore A)

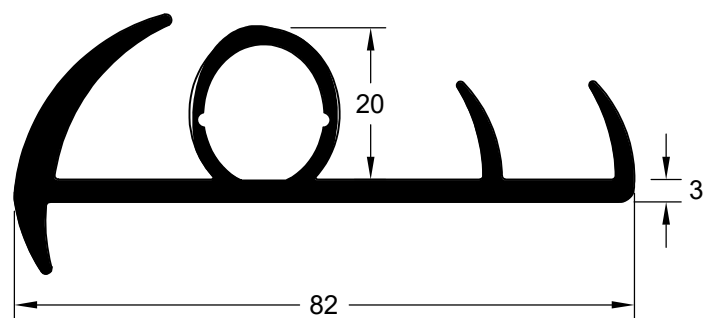

CIA 16803 (EPDM 80 Shore A)

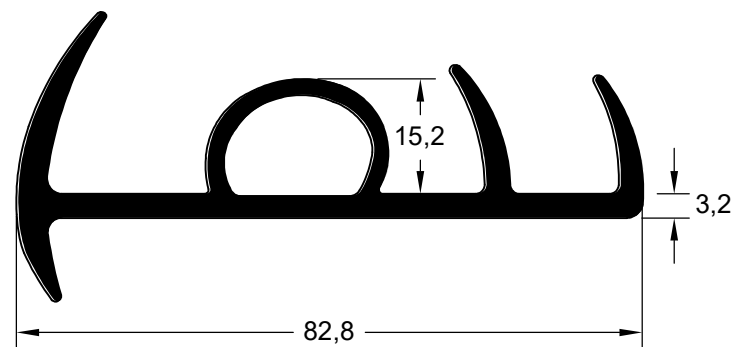

PERFIL MACIÇO

<p>CIA 6475 (EPDM 63 Shore A)</p>	<p>CIA 9037 (EPDM 63 Shore A)</p>	<p>CIA 9038 (EPDM 63 Shore A)</p>	<p>CIA 9033 (EPDM 63 Shore A)</p>
<p>CIA 9034 (EPDM 63 Shore A)</p>	<p>CIA 9012 (EPDM 63 Shore A)</p>	<p>CIA 9056 (EPDM 63 Shore A)</p>	<p>CIA 18649 (EPDM 63 Shore A)</p>
<p>CIA 15875 (EPDM 70 Shore A)</p>	<p>CIA 14841 (EPDM 63 Shore A)</p>	<p>CIA 9055 (EPDM 63 Shore A)</p>	<p>CIA 9084 (EPDM 80 Shore A)</p>
<p>CIA 9059 (EPDM 63 Shore A)</p>	<p>CIA 9090 (EPDM 63 Shore A)</p>	<p>CIA 9133 (EPDM 63 Shore A)</p>	<p>CIA 9151 (EPDM 63 Shore A)</p>

PERFIL MACIÇO

<p>CIA 9065 (EPDM 63 Shore A)</p>	<p>CIA 9108 (EPDM 63 Shore A)</p>	<p>CIA 9015 (EPDM 63 Shore A)</p>	<p>CIA 9047 (EPDM 63 Shore A)</p>
<p>CIA 9085 (EPDM 63 Shore A)</p>	<p>CIA 16843 (EPDM 63 Shore A)</p>	<p>CIA 9014 (EPDM 63 Shore A)</p>	<p>CIA 9146 (EPDM 63 Shore A)</p>
<p>CIA 9018 (EPDM 63 Shore A)</p>	<p>CIA 9125 (EPDM 63 Shore A)</p>	<p>CIA 9048 (EPDM 63 Shore A)</p>	<p>CIA 9004 (EPDM 63 Shore A)</p>
<p>CIA 19178 (EPDM 63 Shore A)</p>	<p>CIA 9122 (EPDM 70 Shore A)</p>	<p>CIA 9035 (EPDM 63 Shore A)</p>	<p>CIA 9036 (EPDM 63 Shore A)</p>

PERFIL MACIÇO

<p>CIA 9001 (EPDM 70 Shore A)</p>	<p>CIA 9029 (EPDM 63 Shore A)</p>	<p>CIA 9032 (EPDM 63 Shore A)</p>	<p>CIA 9112 (EPDM 70 Shore A)</p>
<p>CIA 16515 (EPDM 70 Shore A)</p>	<p>CIA 6506 (EPDM 70 Shore A)</p>	<p>CIA 9070 (EPDM 70 Shore A)</p>	<p>CIA 9103 (EPDM 70 Shore A)</p>
<p>CIA 9138 (EPDM 70 Shore A)</p>	<p>CIA 9087 (EPDM 63 Shore A)</p>	<p>CIA 9054 (EPDM 63 Shore A)</p>	<p>CIA 9016 (EPDM 63 Shore A)</p>

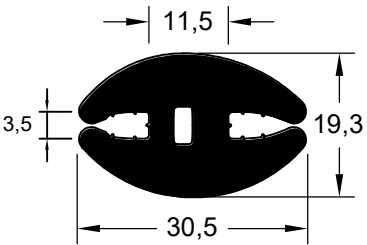
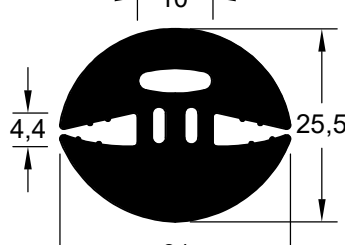
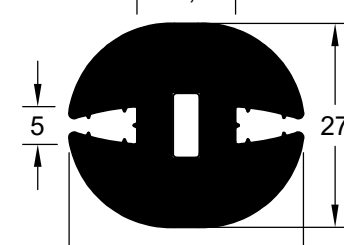
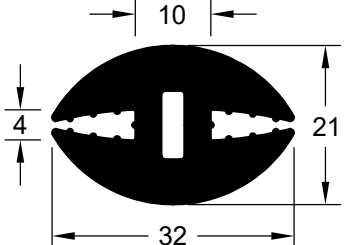
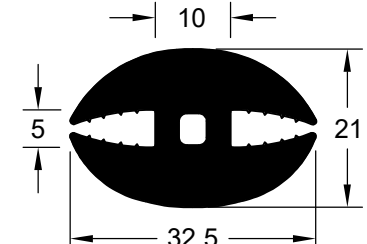
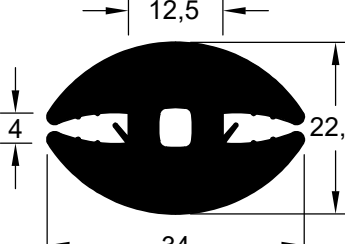
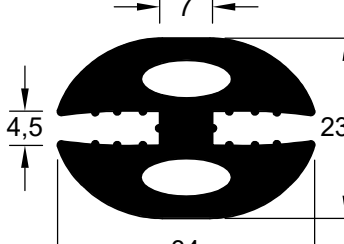
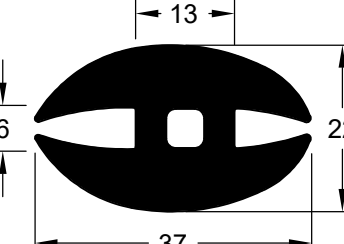
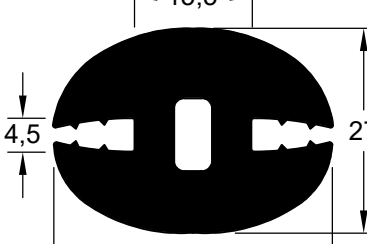
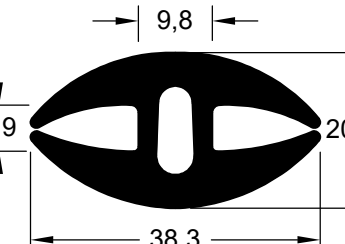
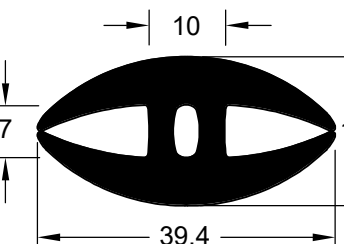
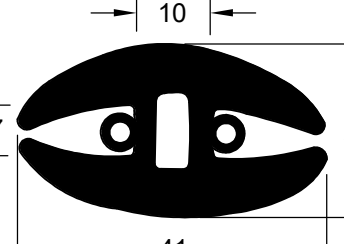
<p>CIA 9039 (EPDM 63 Shore A)</p> 	<p>CIA 9089 (EPDM 63 Shore A)</p> 	<p>CIA 9002 (EPDM 63 Shore A)</p> 	<p>CIA 9091 (EPDM 63 Shore A)</p> 
<p>CIA 9031 (EPDM 63 Shore A)</p> 	<p>CIA 9157 (EPDM 63 Shore A)</p> 	<p>CIA 18647 (EPDM 63 Shore A)</p> 	<p>CIA 9007 (EPDM 63 Shore A)</p> 
<p>CIA 9052 (EPDM 63 Shore A)</p> 	<p>CIA 18651 (EPDM 63 Shore A)</p> 	<p>CIA 14803 (EPDM 63 Shore A)</p> 	<p>CIA 15974 (EPDM 70 Shore A)</p> 

PERFIL MACIÇO

<p>CIA 9107 (EPDM 63 Shore A)</p>	<p>CIA 9109 (EPDM 80 Shore A)</p>	<p>CIA 9081 (EPDM 80 Shore A)</p>	<p>CIA 9141 (EPDM 70 Shore A)</p>
<p>CIA 14847 (EPDM 63 Shore A)</p>	<p>CIA 9068 (EPDM 63 Shore A)</p>	<p>CIA 14199 (EPDM 63 Shore A)</p>	<p>CIA 9017 (EPDM 63 Shore A)</p>
<p>CIA 9023 (EPDM 63 Shore A)</p>	<p>CIA 15057 (EPDM 80 Shore A)</p>	<p>CIA 9093 (EPDM 80 Shore A)</p>	<p>CIA 9057 (EPDM 63 Shore A)</p>

PERFIL MACIÇO

<p>CIA 9026 (EPDM 63 Shore A)</p>	<p>CIA 9119 (EPDM 70 Shore A)</p>	<p>CIA 18606 (EPDM 70 Shore A)</p>	<p>CIA 9076 (EPDM 70 Shore A) CIA 17116 (EPDM 63 Shore A)</p>
<p>CIA 9080 (EPDM 63 Shore A)</p>	<p>CIA 9063 (EPDM 63 Shore A)</p>	<p>CIA 9049 (EPDM 63 Shore A)</p>	
<p>CIA 9021 (EPDM 63 Shore A)</p>	<p>CIA 9086 (EPDM 63 Shore A)</p>	<p>CIA 9028 (EPDM 63 Shore A)</p>	

PERFIL MACIÇO

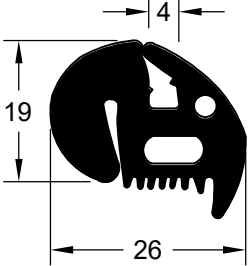
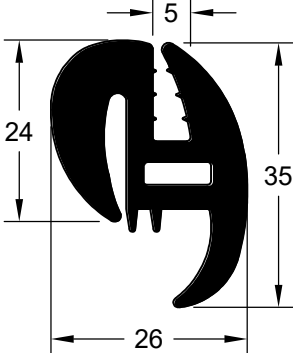
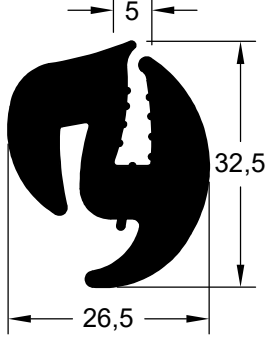
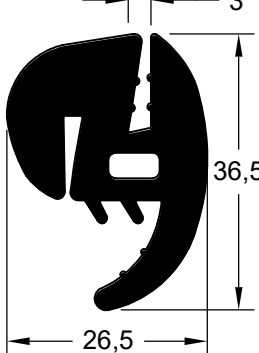
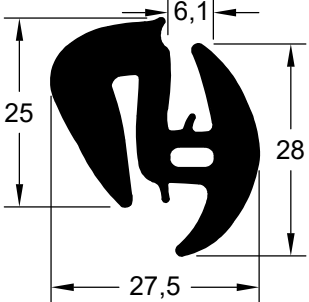
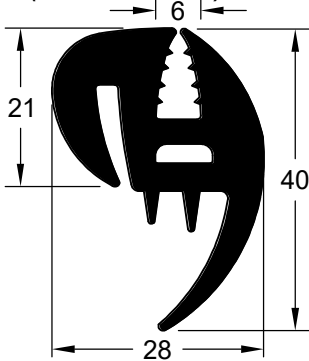
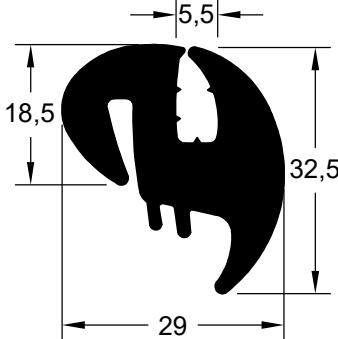
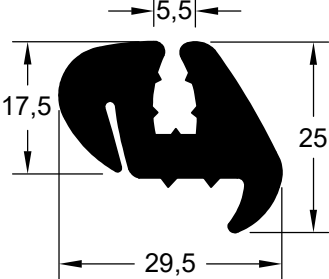
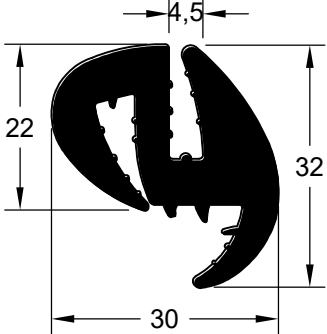
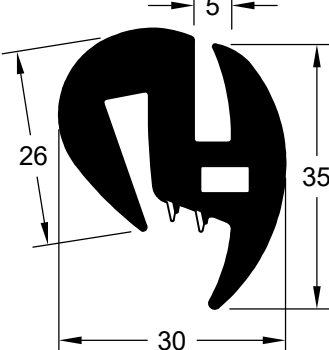
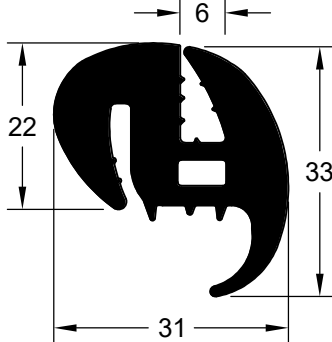
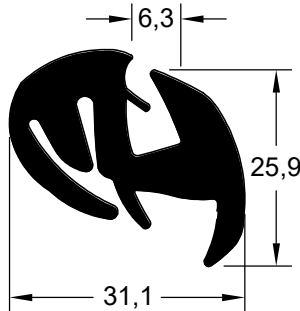
<p><i>CIA 14263 (EPDM 80 Shore A)</i></p> 	<p><i>CIA 9074 (EPDM 63 Shore A)</i></p> 	<p><i>CIA 9098 (EPDM 80 Shore A)</i></p> 	<p><i>CIA 9053 (EPDM 80 Shore A)</i></p> 
<p><i>CIA 17543 (EPDM 63 Shore A)</i></p> 	<p><i>CIA 9011 (EPDM 63 Shore A)</i></p> 	<p><i>CIA 9009 (EPDM 63 Shore A)</i></p> 	<p><i>CIA 9006 (EPDM 63 Shore A)</i></p> 
<p><i>CIA 9022 (EPDM 63 Shore A)</i></p> 	<p><i>CIA 9060 (EPDM 63 Shore A)</i></p> 	<p><i>CIA 9010 (EPDM 63 Shore A)</i></p> 	<p><i>CIA 16622 (EPDM 63 Shore A)</i></p> 

PERFIL MACIÇO

<p>CIA 9045 (EPDM 80 Shore A)</p>	<p>CIA 9046 (EPDM 63 Shore A)</p>	<p>CIA 9019 (EPDM 63 Shore A)</p>	<p>CIA 9044 (EPDM 63 Shore A)</p>
<p>CIA 18190 (EPDM 63 Shore A)</p>	<p>CIA 9082 (EPDM 63 Shore A)</p>	<p>CIA 9025 (EPDM 80 Shore A)</p>	<p>CIA 9013 (EPDM 63 Shore A)</p>
<p>CIA 9062 (EPDM 63 Shore A)</p>	<p>CIA 9094 (EPDM 63 Shore A)</p>	<p>CIA 9066 (EPDM 63 Shore A)</p>	<p>CIA 9008 (EPDM 63 Shore A)</p>

PERFIL MACIÇO

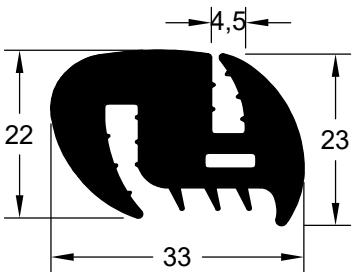
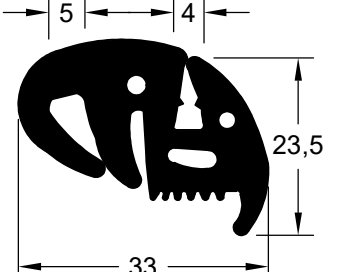
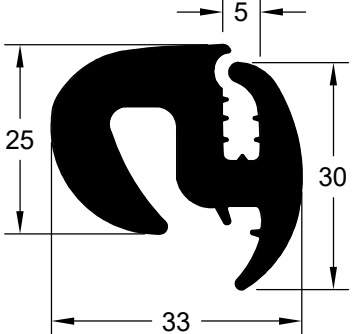
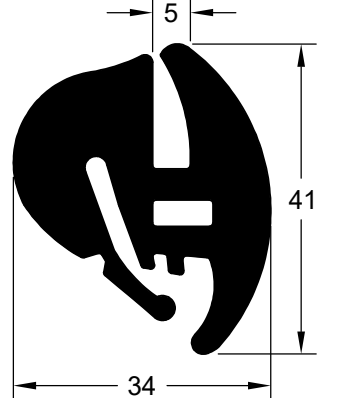
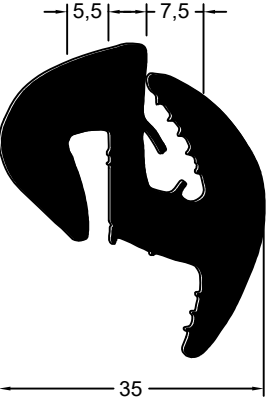
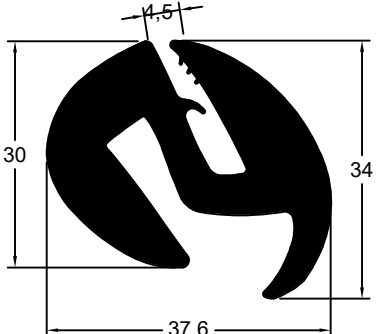
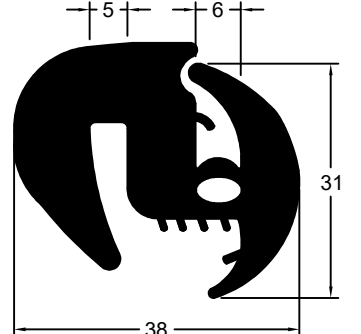
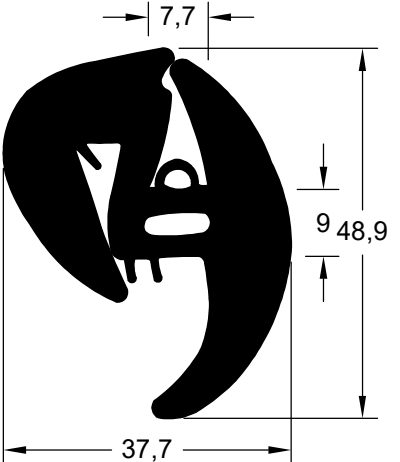
<p><i>CIA 9041 (EPDM 63 Shore A)</i></p> 	<p><i>CIA 14261 (EPDM 63 Shore A)</i></p> 	<p><i>CIA 9043 (EPDM 70 Shore A)</i></p> 	<p><i>CIA 9079 (EPDM 63 Shore A)</i></p> 
<p><i>CIA 14664 (EPDM 63 Shore A)</i></p> 	<p><i>CIA 17542 (EPDM 63 Shore A)</i></p> 	<p><i>CIA 14299 (EPDM 63 Shore A)</i></p> 	<p><i>CIA 15973 (EPDM 70 Shore A)</i></p> 

PERFIL MACIÇO

<p>CIA 9078 (EPDM 63 Shore A)</p>	<p>CIA 16845 (EPDM 63 Shore A)</p>	<p>CIA 9113 (EPDM 63 Shore A)</p>	<p>CIA 18650 (EPDM 63 Shore A)</p>
<p>CIA 15031 (EPDM 63 Shore A)</p>	<p>CIA 9005 (EPDM 63 Shore A) CIA 17906 (EPDM 55 Shore A)</p>	<p>CIA 15082 (EPDM 70 Shore A)</p>	<p>CIA 17523 (EPDM 63 Shore A)</p>

PERFIL MACIÇO

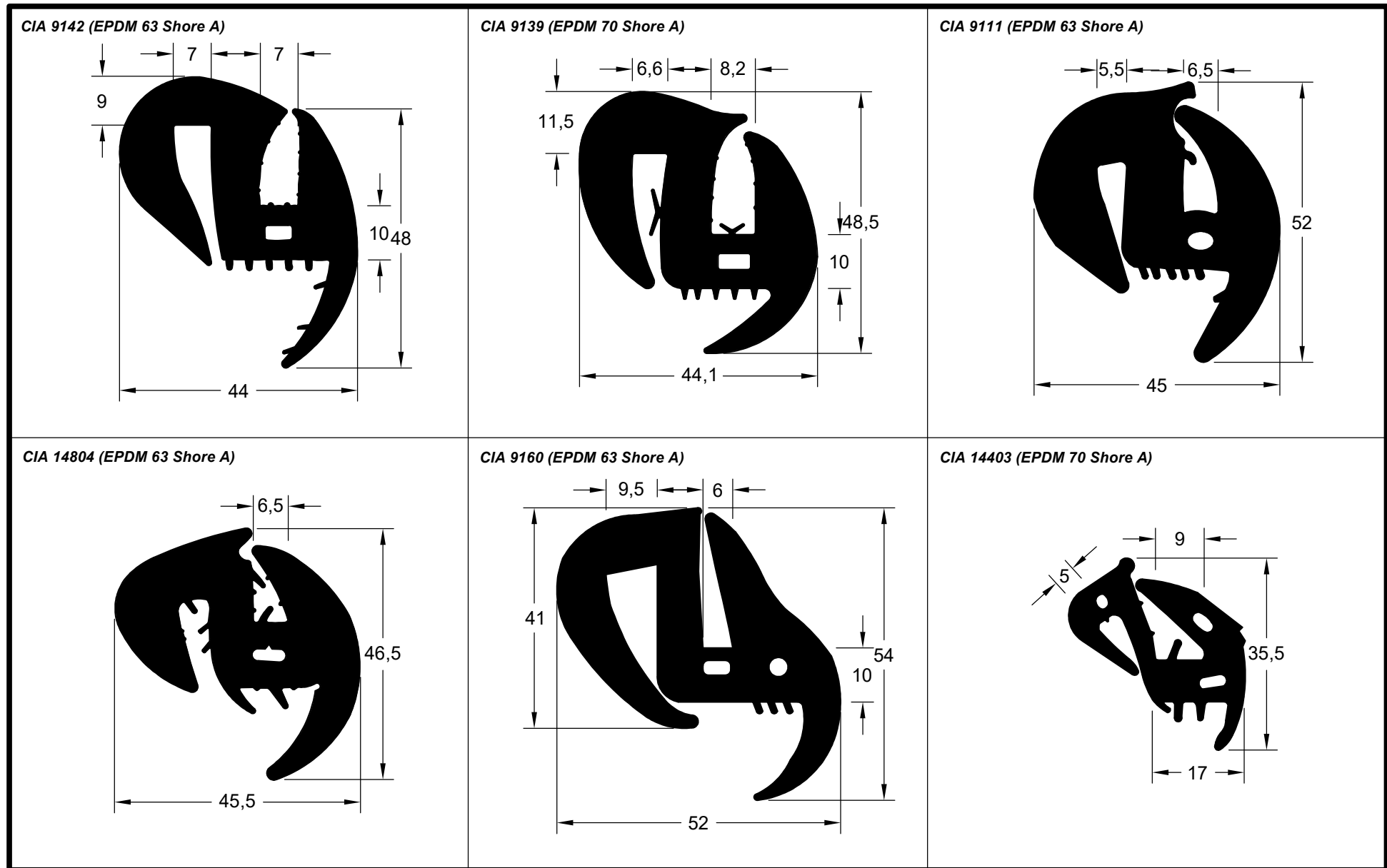

PERFIL MACIÇO

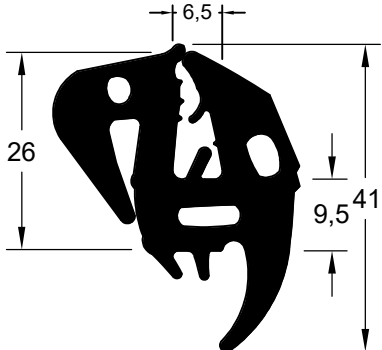
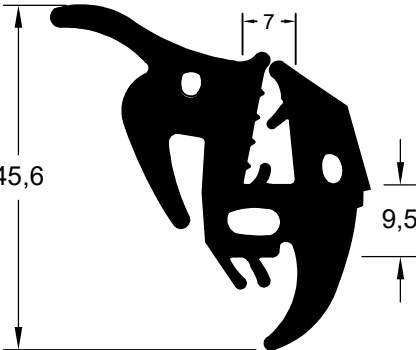
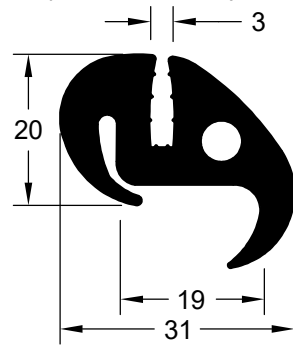
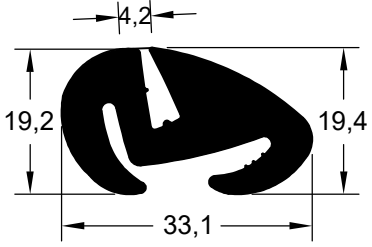
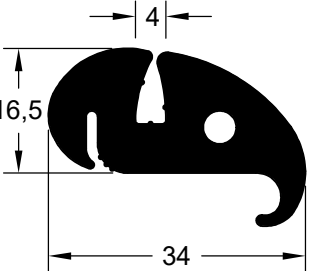
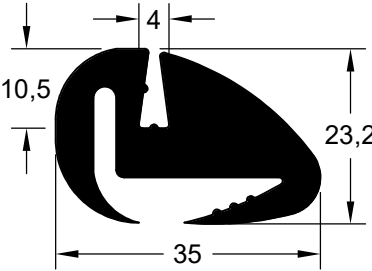
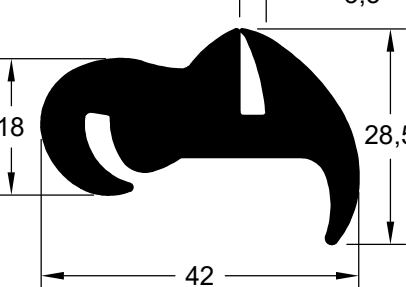
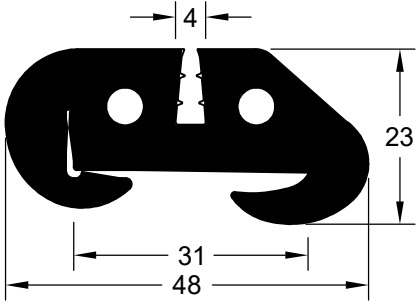
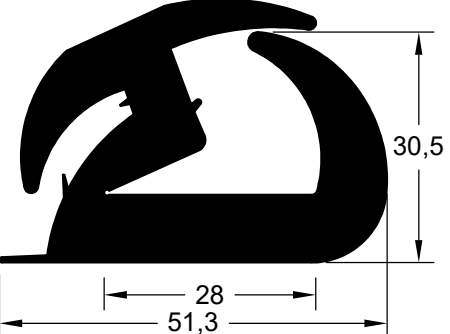
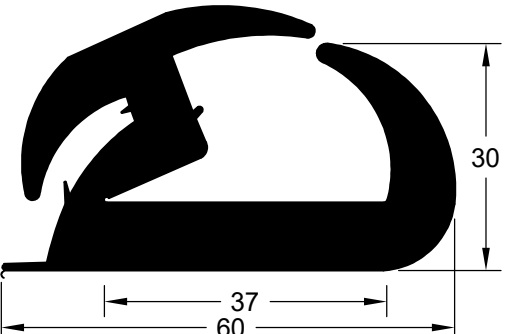
<p>CIA 14401 (EPDM 70 Shore A)</p> 	<p>CIA 14402 (EPDM 70 Shore A)</p> 	<p>CIA 9027 (EPDM 63 Shore A)</p> 	<p>CIA 18199 (EPDM 63 Shore A)</p> 
<p>CIA 9106 (EPDM 63 Shore A)</p> 	<p>CIA 9128 (EPDM 70 Shore A)</p> 	<p>CIA 9050 (EPDM 63 Shore A)</p> 	<p>CIA 9061 (EPDM 63 Shore A)</p> 
<p>CIA 9075 (EPDM 80 Shore A)</p> 		<p>CIA 19016 (EPDM 80 Shore A)</p> 	

PERFIL MACIÇO

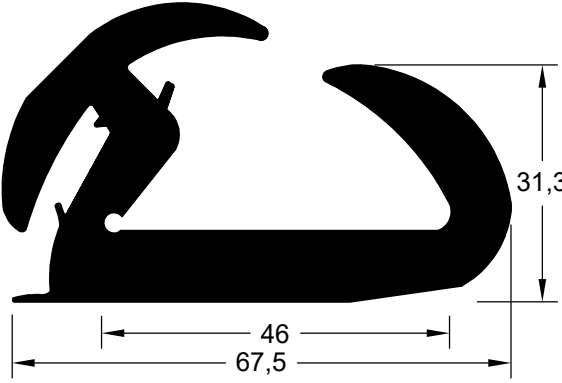
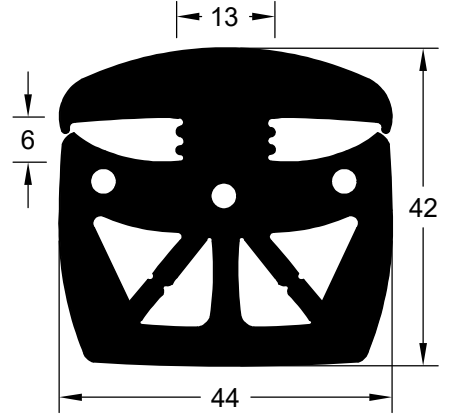
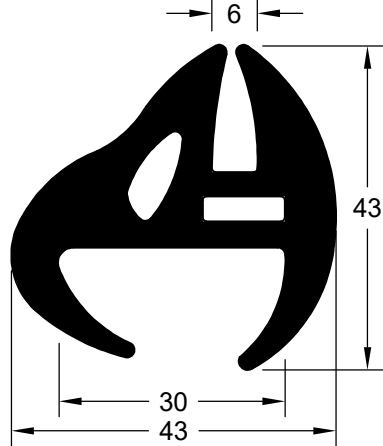
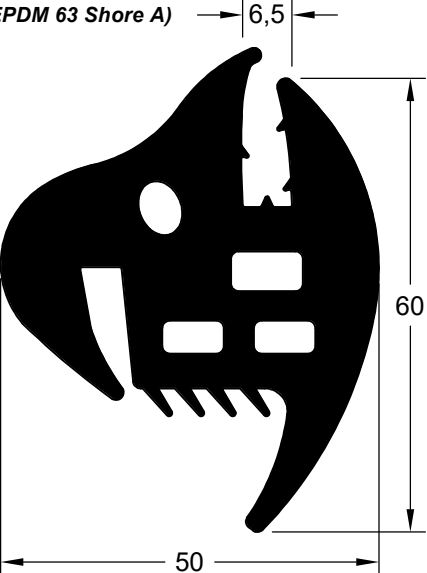
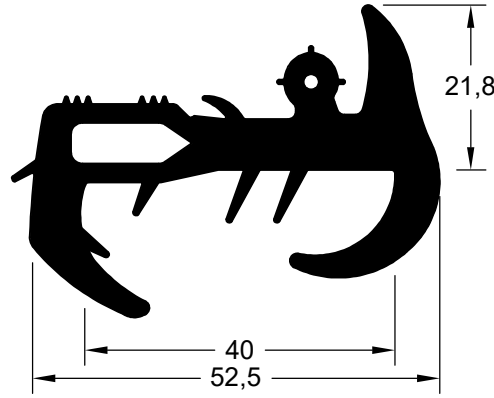
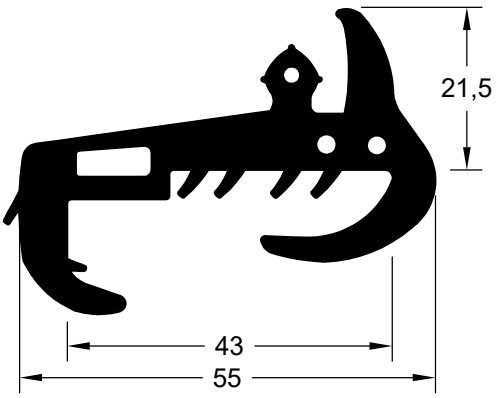
<p><i>CIA 9077 (EPDM 80 Shore A)</i></p>  <p>Dimensions: 46, 67,5, 31,3</p>	<p><i>CIA 9143 (EPDM 63 Shore A)</i></p>  <p>Dimensions: 13, 6, 42, 44</p>	<p><i>CIA 9073 (EPDM 63 Shore A)</i></p>  <p>Dimensions: 6, 43, 30, 43</p>
<p><i>CIA 9095 (EPDM 63 Shore A)</i></p>  <p>Dimensions: 6,5, 60, 50</p>	<p><i>CIA 9100 (EPDM 63 Shore A)</i></p>  <p>Dimensions: 21,8, 40, 52,5</p>	<p><i>CIA 9024 (EPDM 63 Shore A)</i></p>  <p>Dimensions: 21,5, 43, 55</p>

PERFIL MACIÇO

CIA 9102 (EPDM 63 Shore A)

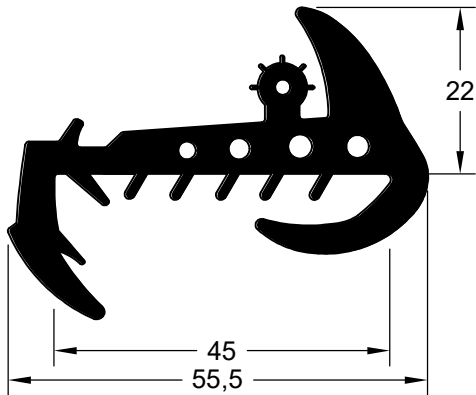

CIA 9120 (EPDM 70 Shore A)

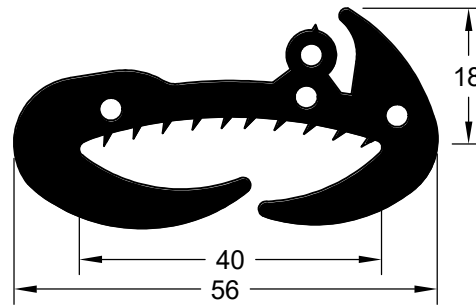

CIA 9127 (EPDM 63 Shore A)

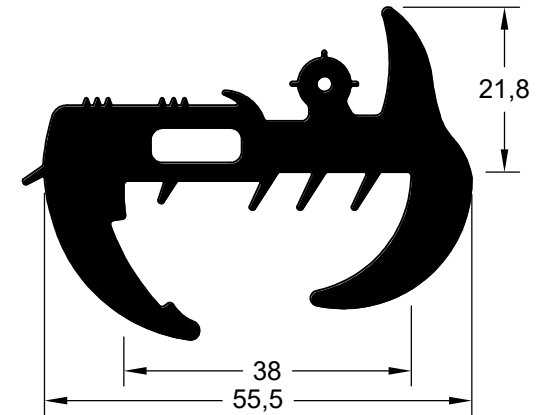

CIA 9115 (EPDM 63 Shore A)

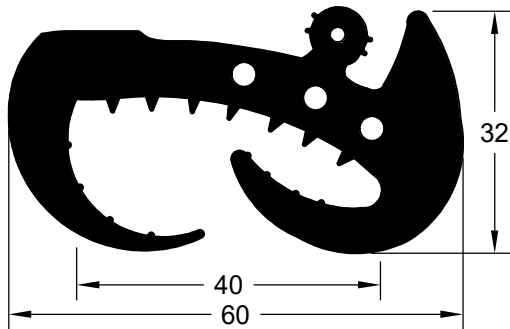

CIA 15467 (EPDM 63 Shore A)

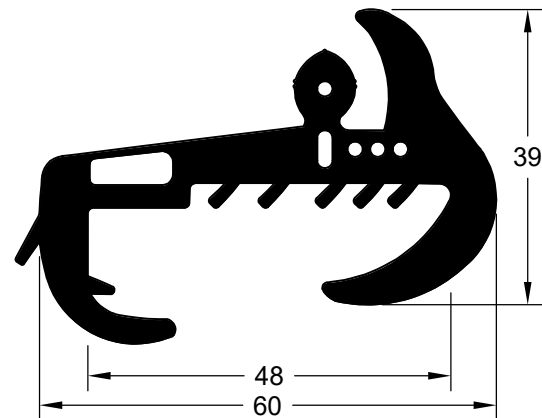

CIA 9159 (EPDM 70 Shore A)

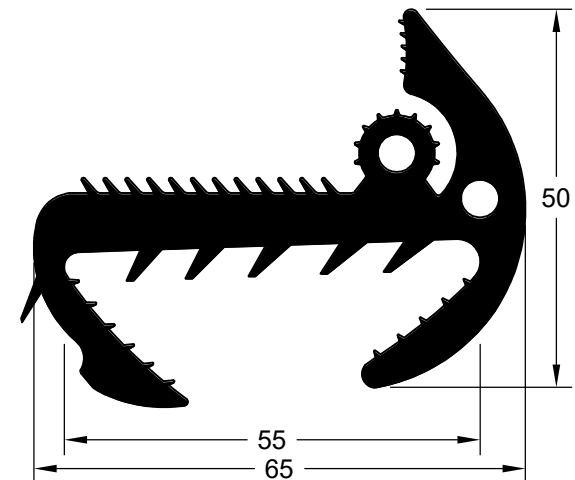

PERFIL MACIÇO

CIA 9096 (EPDM 63 Shore A)

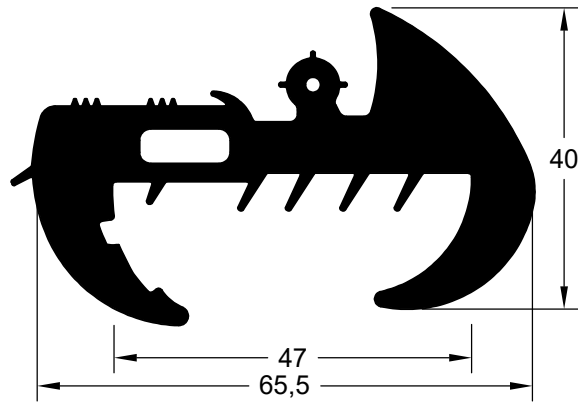

CIA 18967 (EPDM 70 Shore A)

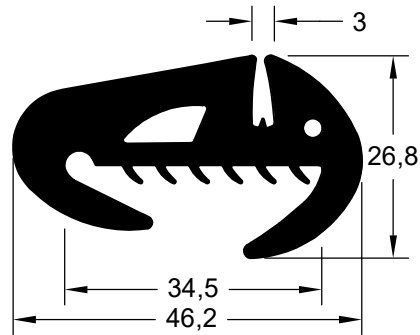

CIA 9126 (EPDM 63 Shore A)

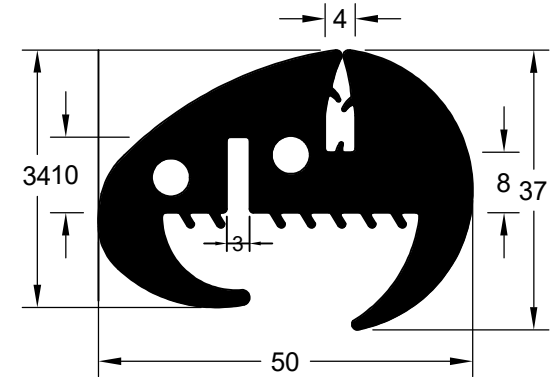

CIA 9158 (EPDM 63 Shore A)

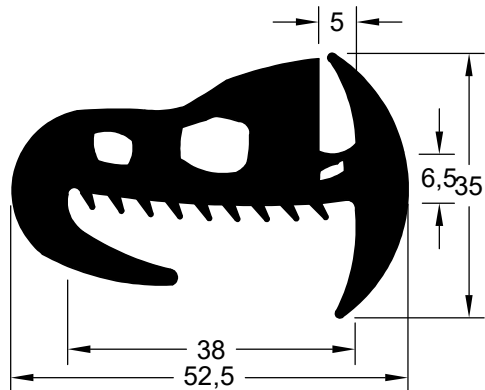

CIA 18648 (EPDM 63 Shore A)

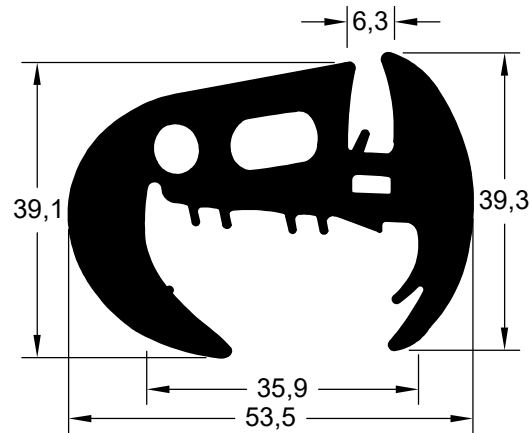

CIA 9042 (EPDM 63 Shore A)

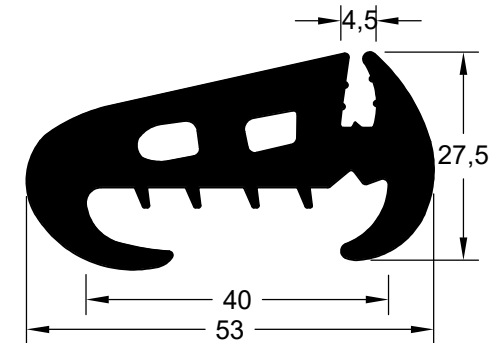

CIA 9147 (EPDM 70 Shore A)

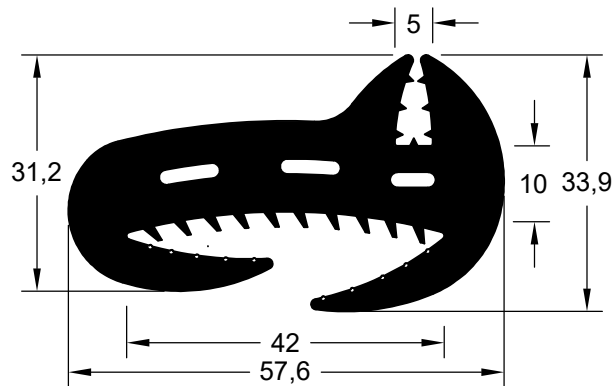

CIA 9148 (EPDM 63 Shore A)

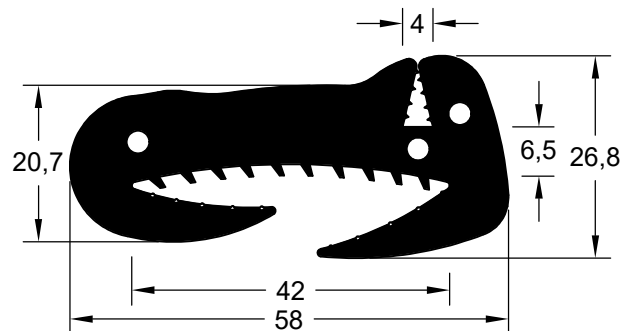

CIA 9083 (EPDM 63 Shore A)

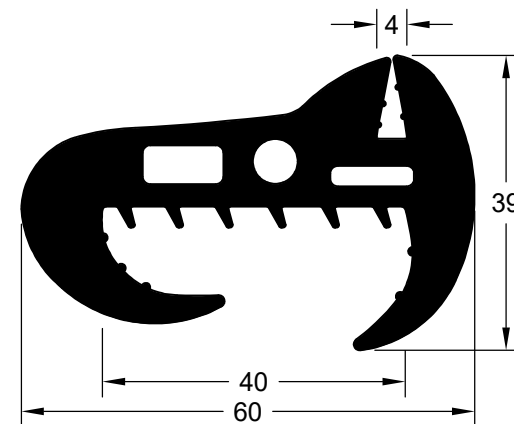

CIA 9121 (EPDM 63 Shore A)

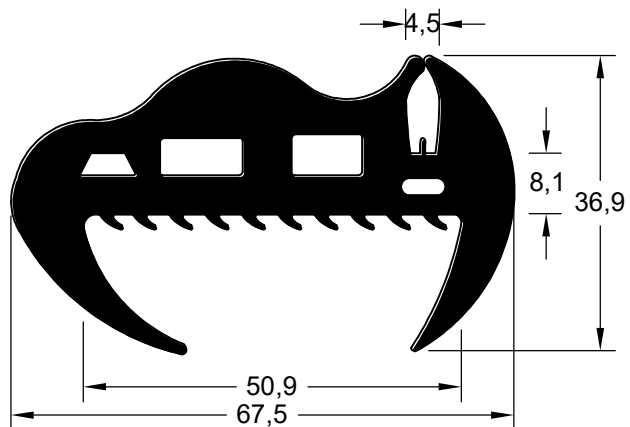

CIA 9140 (EPDM 63 Shore A)

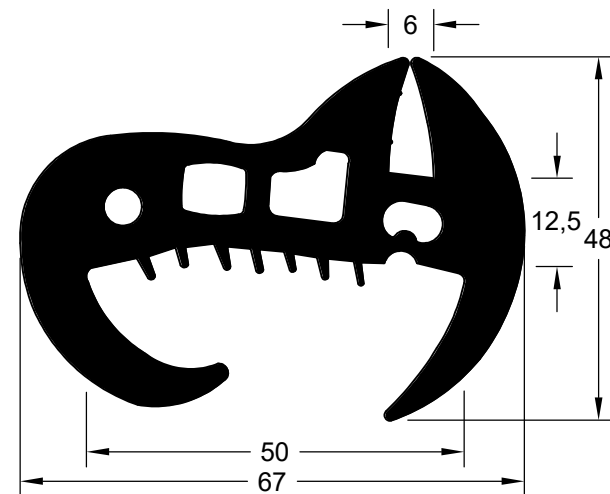

PERFIL MACIÇO

CIA 18646 (EPDM 63 Shore A)

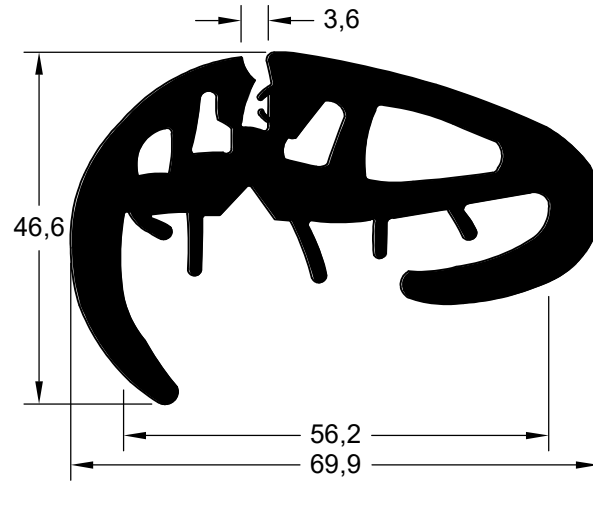

CIA 9129 (EPDM 70 Shore A)

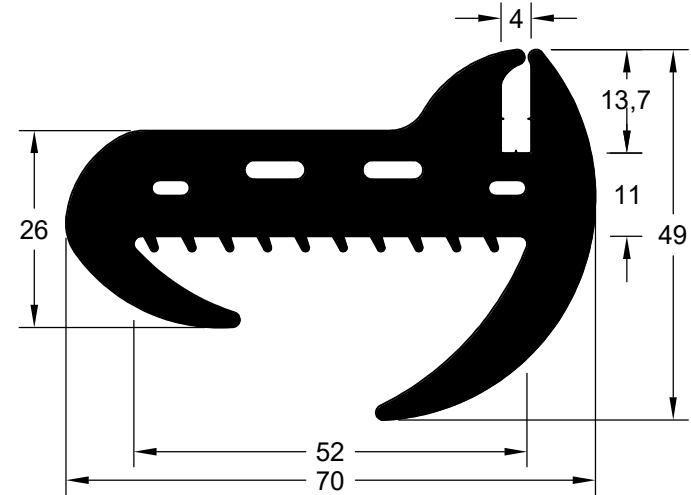

CIA 9092 (EPDM 63 Shore A)

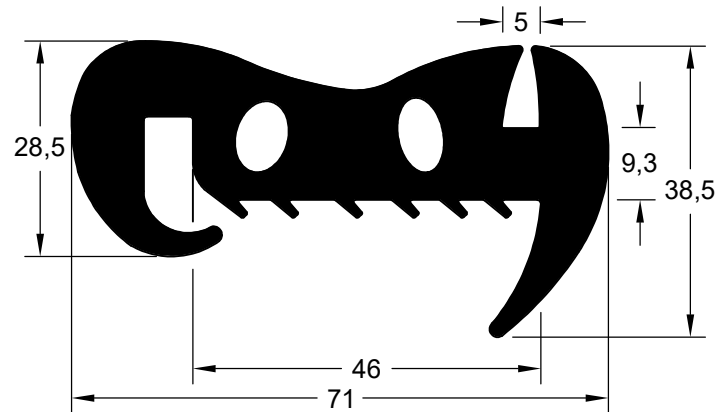

CIA 9123 (EPDM 70 Shore A)

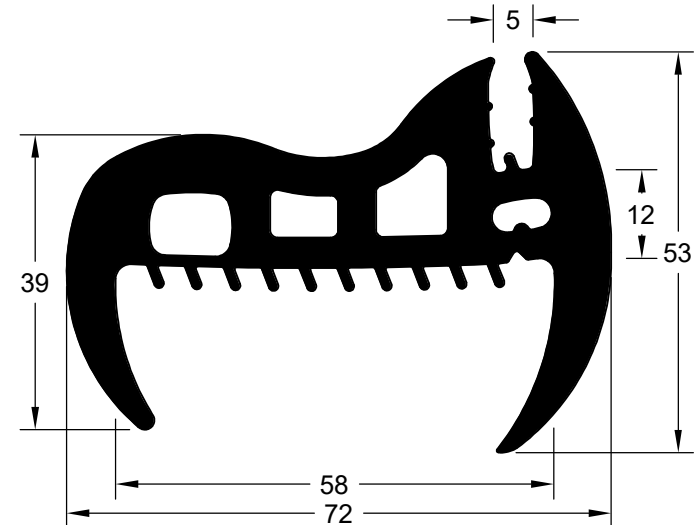

CIA 9130 (EPDM 70 Shore A)

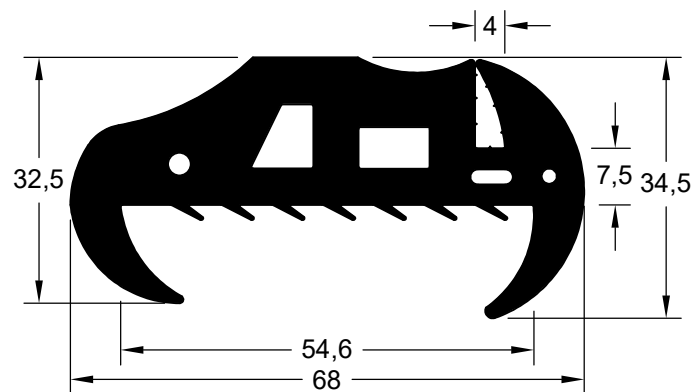

CIA 9097 (EPDM 63 Shore A)

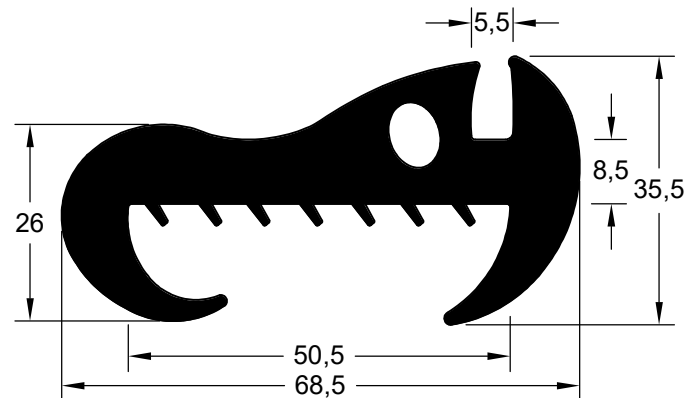

CIA 9131 (EPDM 70 Shore A)

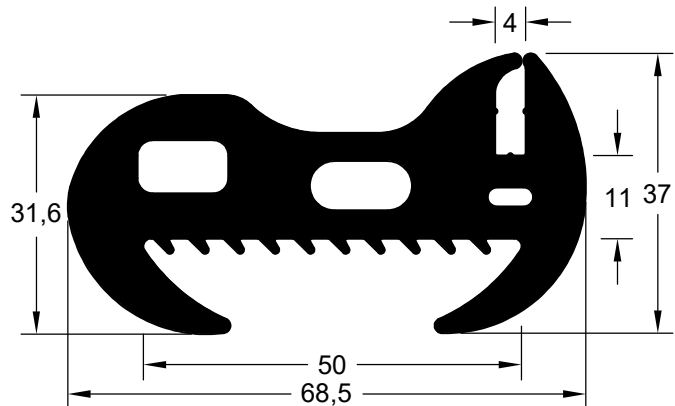

CIA 9145 (EPDM 63 Shore A)

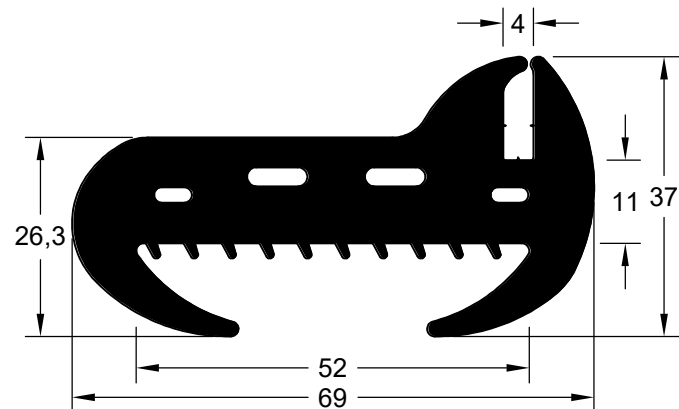

CIA 9072 (EPDM 63 Shore A)

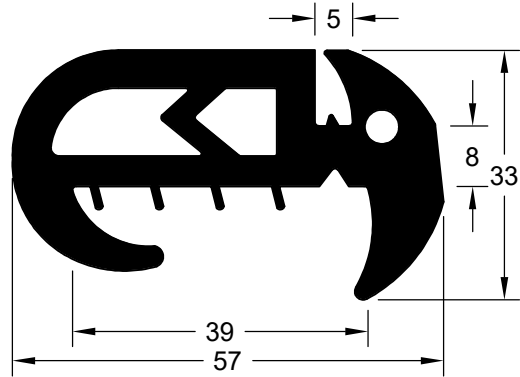

CIA 15423 (EPDM 63 Shore A)

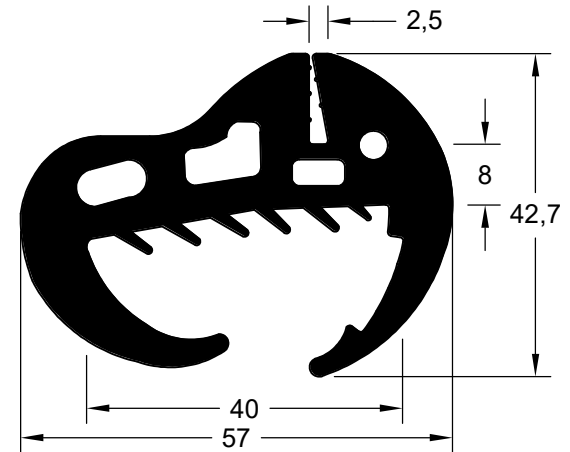

CIA 9020 (EPDM 63 Shore A)

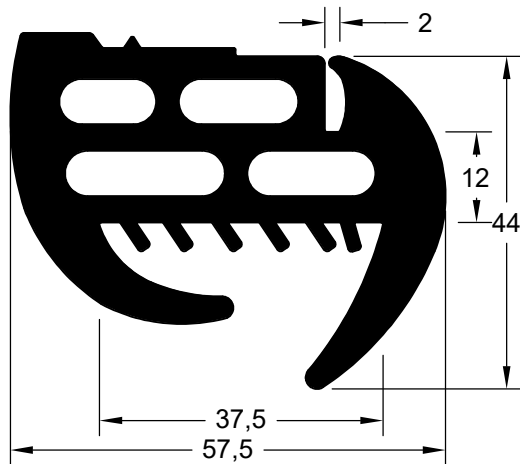

CIA 9064 (EPDM 63 Shore A)

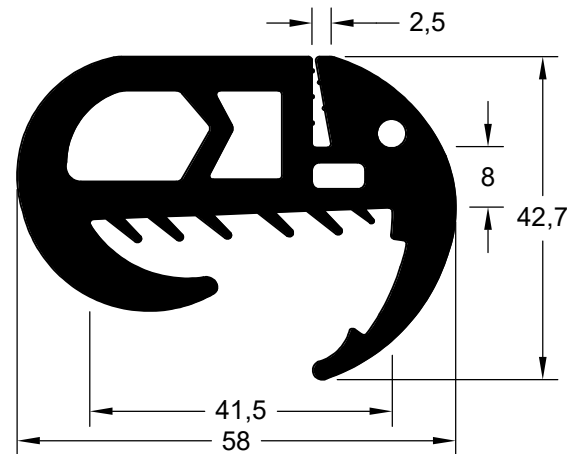

PERFIL MACIÇO

CIA 9153 (EPDM 63 Shore A)

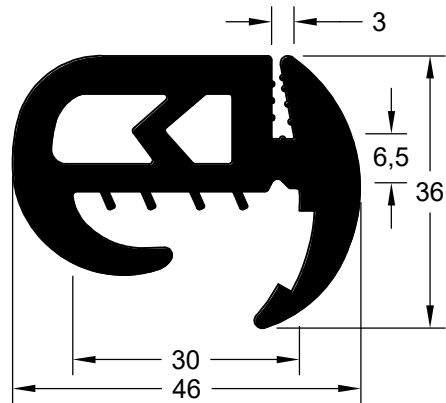

CIA 9040 (EPDM 63 Shore A)

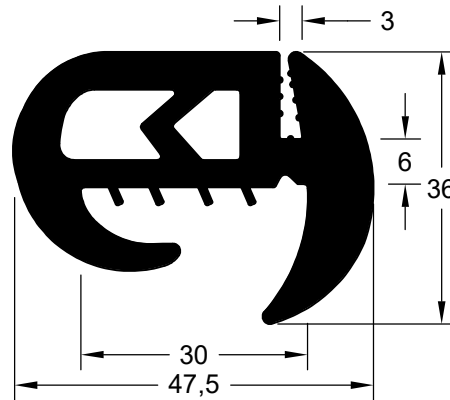

CIA 9152 (EPDM 63 Shore A)

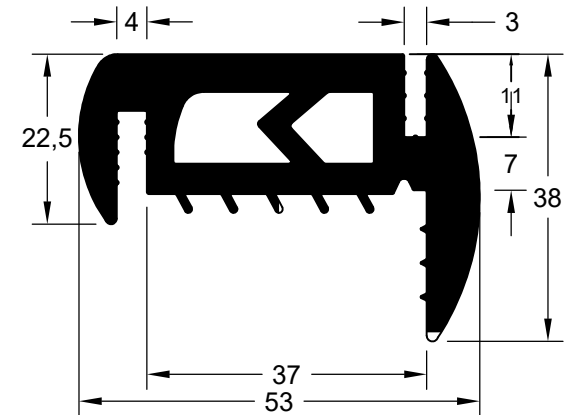

CIA 9003 (EPDM 63 Shore A)

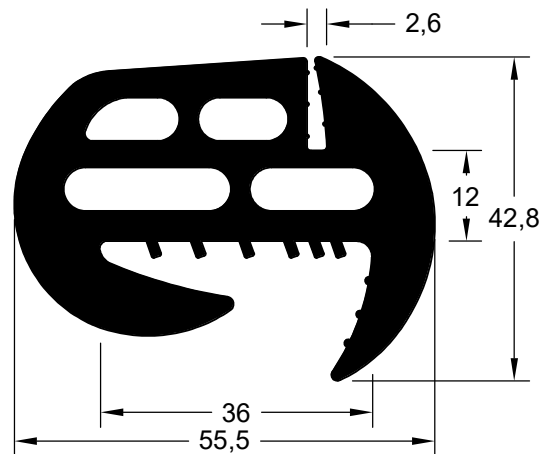

CIA 9088 (EPDM 63 Shore A)

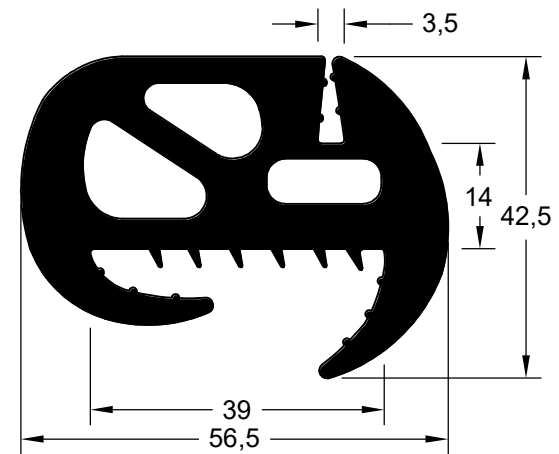

PERFIL MACIÇO

CIA 9051 (EPDM 63 Shore A)

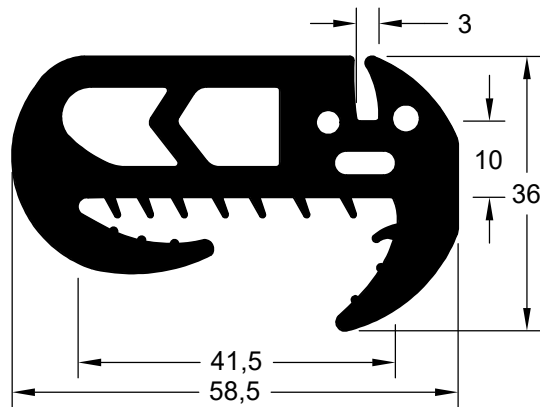

CIA 14697 (EPDM 63 Shore A)

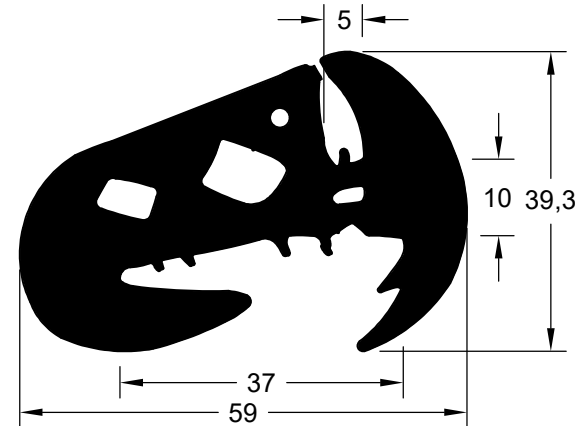

CIA 9114 (EPDM 63 Shore A)

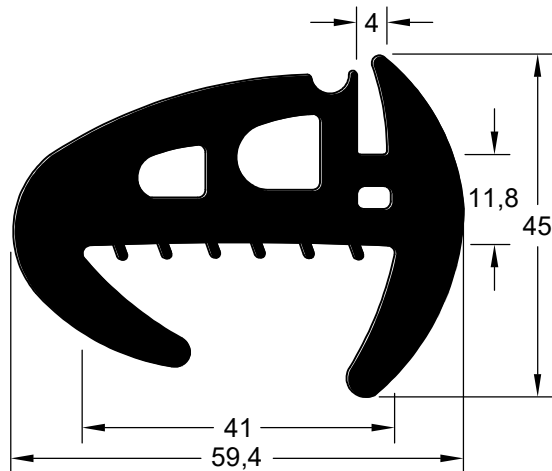

CIA 9161 (EPDM 63 Shore A)

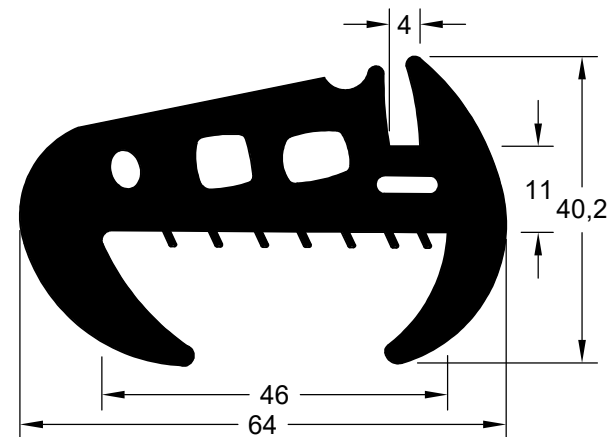

PERFIL MACIÇO

CIA 16022 (EPDM 70 Shore A)

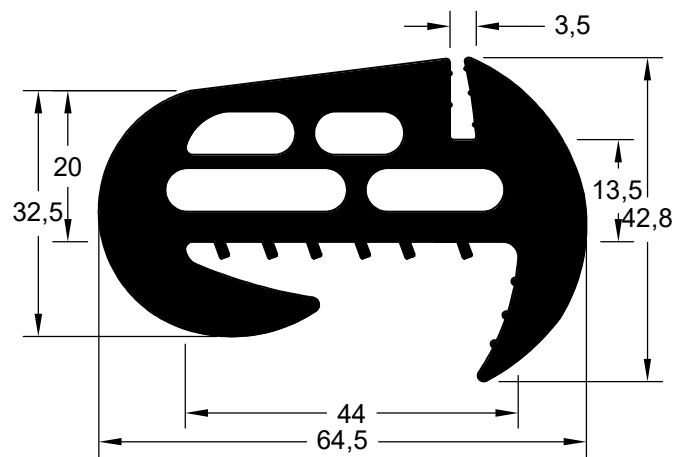

CIA 14882 (EPDM 63 Shore A)

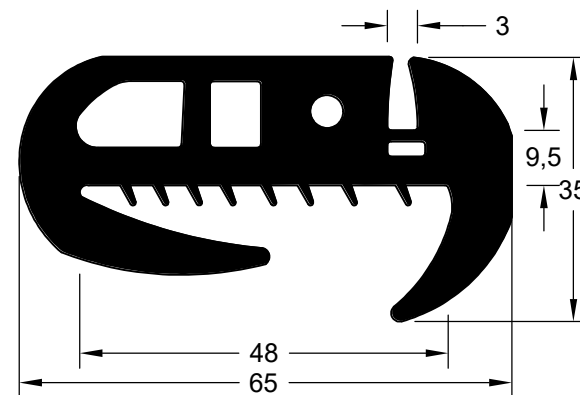

CIA 17263 (EPDM 63 Shore A)

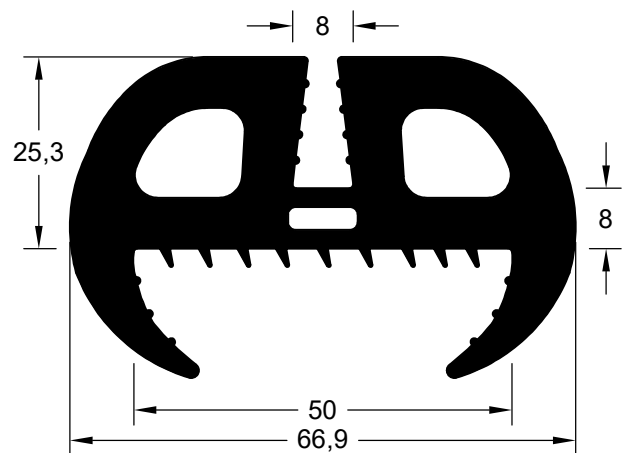

PERFIL FLOCADO

<p><i>CIA 6501 (EPDM canaleta revestida)</i></p>	<p><i>CIA 19819 (EPDM canaleta revestida)</i></p>	<p><i>CIA 18916 (EPDM canaleta revestida)</i></p>	<p><i>CIA 6375 (EPDM canaleta revestida)</i></p>
<p><i>CIA 16952 (EPDM canaleta flocada)</i></p>	<p><i>CIA 6502 (EPDM canaleta flocada)</i></p>	<p><i>CIA 6351 (EPDM canaleta flocada)</i></p>	<p><i>CIA 17388 (EPDM canaleta flocada)</i></p>
<p><i>CIA 16152 (EPDM flocada)</i></p>	<p><i>CIA 16157 (EPDM flocada)</i></p>	<p><i>CIA 19818 (EPDM flocada)</i></p>	<p><i>CIA 16757 (EPDM Flocada)</i></p>

PERFIL BIELASTÔMERO

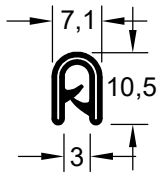
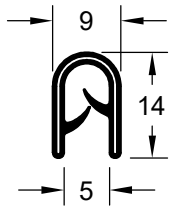
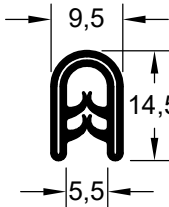
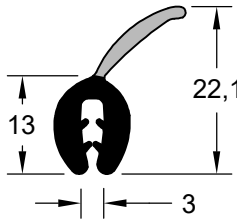
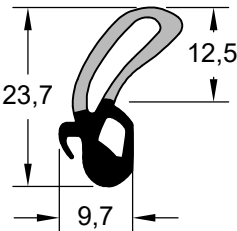
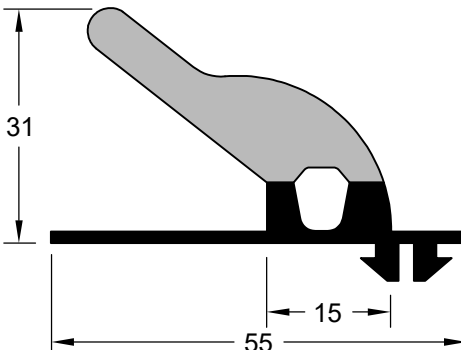
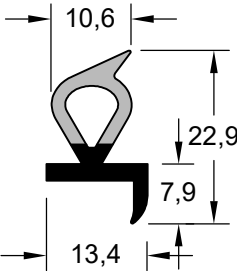
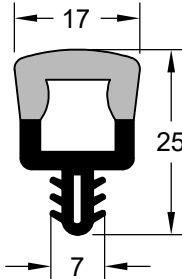
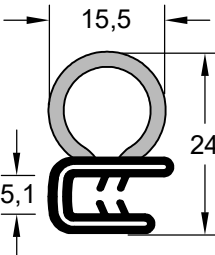
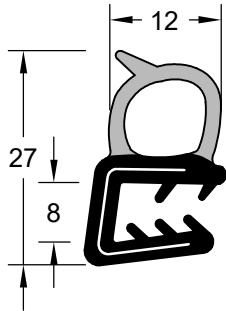
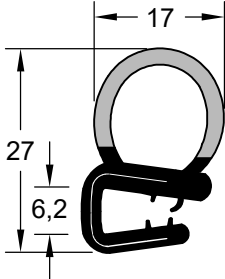
<p>CIA 16533 (PVC)</p> 	<p>CIA 18588 (PVC)</p> 	<p>CIA 0501 (PVC)</p> 	<p>CIA 16570</p> 
<p>CIA 17686</p> 	<p>CIA 19464</p> 	<p>CIA 20025</p> 	
<p>CIA 19982</p> 	<p>CIA 0508</p> 	<p>CIA 0513</p> 	<p>CIA 0511</p> 

PERFIL BIELASTÔMERO

<p>CIA 16692</p>	<p>CIA 14245</p>	<p>CIA 0506</p>	<p>CIA 18217</p>
<p>CIA 17166</p>	<p>CIA 0516</p>	<p>CIA 19569</p>	<p>CIA 16671</p>
<p>CIA 0504</p>	<p>CIA 19899</p>	<p>CIA 19878</p>	<p>CIA 19979</p>

PERFIL BIELASTÔMERO

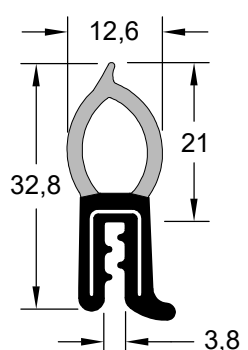
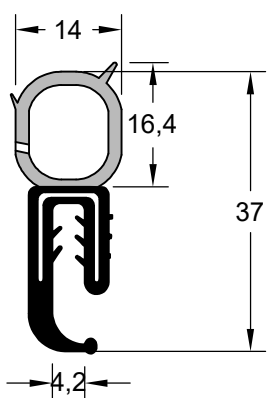
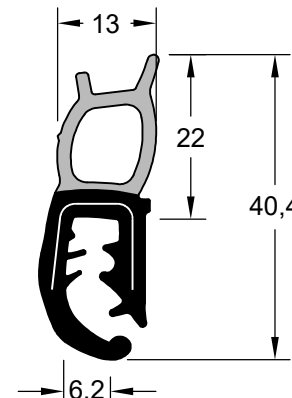
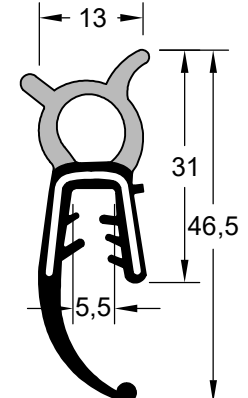
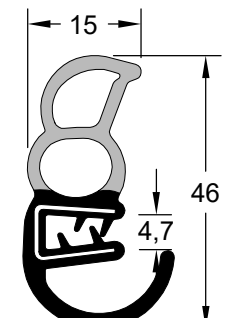
<p><i>CIA 0505</i></p> 	<p><i>CIA 0514</i></p> 	<p><i>CIA 17338</i></p> 	<p><i>CIA 19276</i></p> 
<p><i>CIA 19980</i></p> 			



54 2992 3500 - 9 9703 7732
CIAFLEX@CIAFLEX.COM.BR

RS 122 - KM 84 - S/Nº - VILA MAESTRA
CAXIAS DO SUL - RS